

# IRON BALTIC

## ALUMIINIUM PÕHJAKAITSE

# GOES

# 625 MAX

Kood 02.5000

Version 23102023

DOWNLOAD MULTILINGUAL  
USER MANUAL



[code.ironbaltic.com/u/ZbQ1usHf](https://code.ironbaltic.com/u/ZbQ1usHf)

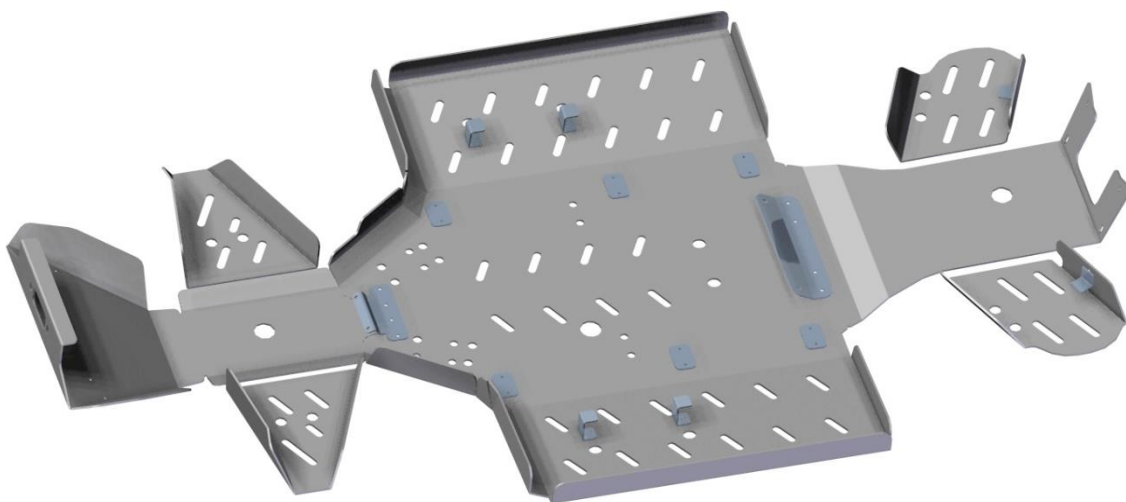

**Hoidke käesolev juhend alles edaspidiseks kasutamiseks!**

Varuosade soovi korral esitage käesoleva lehe koopia või ülal märgitud andmed sõiduki margi, mudeli ja toote seerianumbrite kohta toote müüjale või tootjale aadressile [sales@ironbaltic.com](mailto:sales@ironbaltic.com)

# SPETSIFIKATSIOON

Pos.	Nimetus	Kood	Kogus
1	Põhjakaitse keskosa	02.5001	1
2	Põhjakaitse esiosa	02.5002	1
3	Põhjakaitse tagaos	02.5003	1
4	Vasakpoolne küljekaitse	02.5005K	1
5	Parempoolne küljekaitse	02.5004K	1
6	Vasakpoolne esiõõtshoova kaitse	02.1075V+	1
7	Parempoolne esiõõtshoova kaitse	02.1075P+	1
8	Vasakpoolne tagaõõtshoova kaitse	02.1076V+	1
9	Parempoolne tagaõõtshoova kaitse	02.1076P+	1
10	Kinnitusplaat	02.5008+	1
11	Kinnitusplaat	02.1072+	1
12	Plaat	02.5006	6
13	Kronstein	02.6408	4
14	Nurk	03.1502	2
15	Klambri vastus 38mm	OT.05.04.030	2
16	Kruvi 3,5x22 DIN7981	OT.01.02.004	2
17	Polt M6x12 DIN 933	OT.02.02.030	12
18	Polt M6x16 DIN 7991	OT.02.04.020	12
19	Polt M6x20 DIN 933	OT.02.02.060	8
20	Polt M6x70 DIN 933	OT.02.02.150	4
21	Polt M8x16 DIN 933	OT.02.02.170	10
22	Polt M8x20 DIN 933	OT.02.02.180	2
23	Koonusseib Ø6	14.502	12
24	Nõgus seib	14.503	22
25	Seib Ø5/15 DIN 9021	OT.04.02.010	2
26	Seib Ø6/15 SFS 3738	OT.04.03.020	32
27	Seib Ø8/20 SFS 3738	OT.04.03.030	4
28	Nyloc mutter M6 DIN 985	OT.03.02.030	8

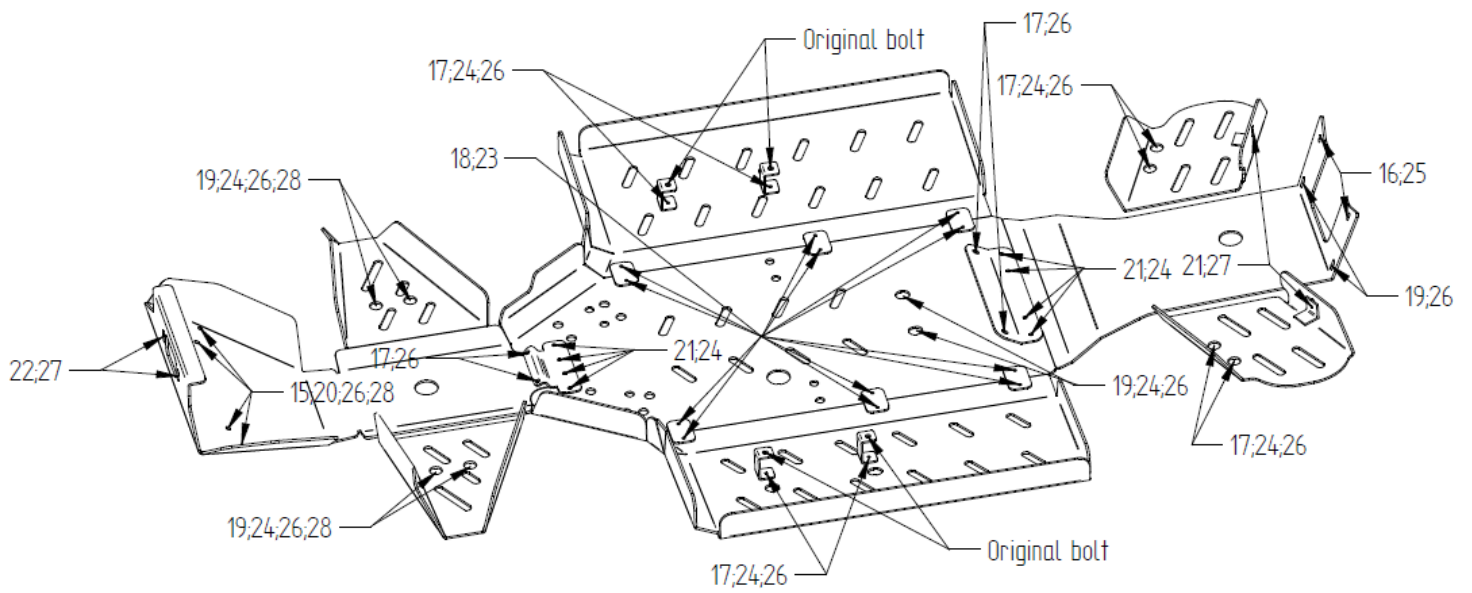
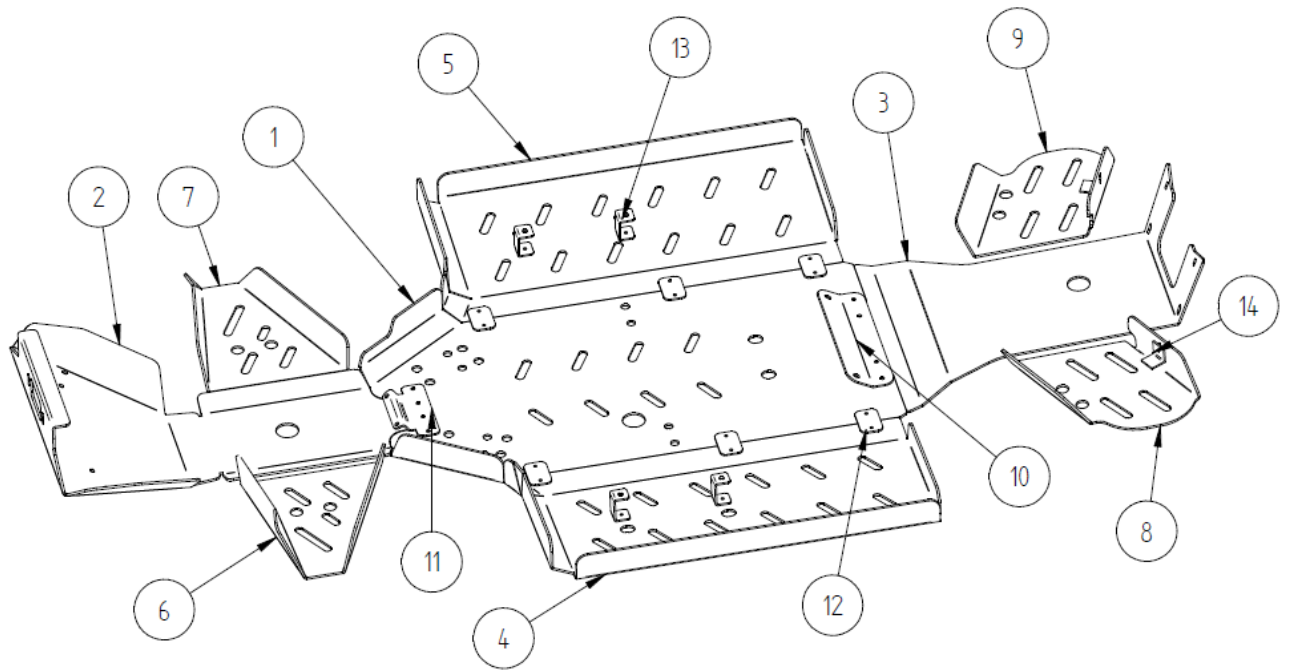

# PAIGALDUSJUHEND

**Samm 1** Eemalda originaal plastikkaitsemed ja rullik.

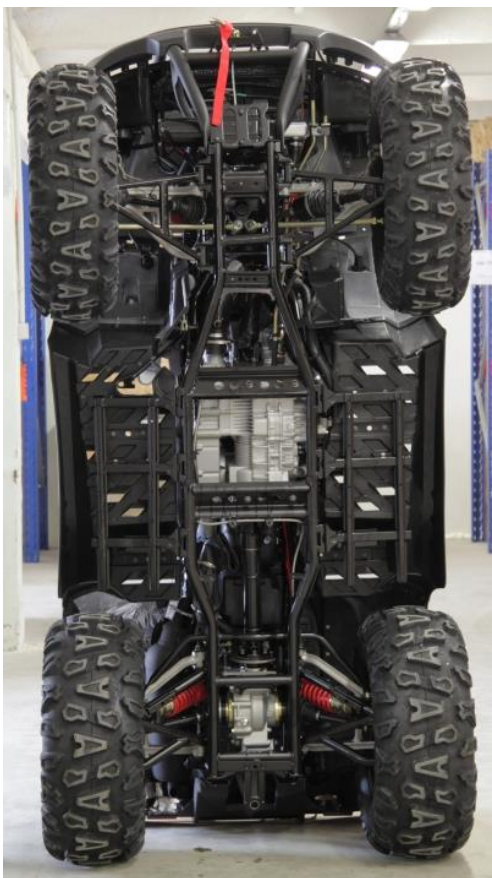

**Samm 2** Paigalda kinnitusplaadid 02.1072+, 02.5008+ ja 02.6408.

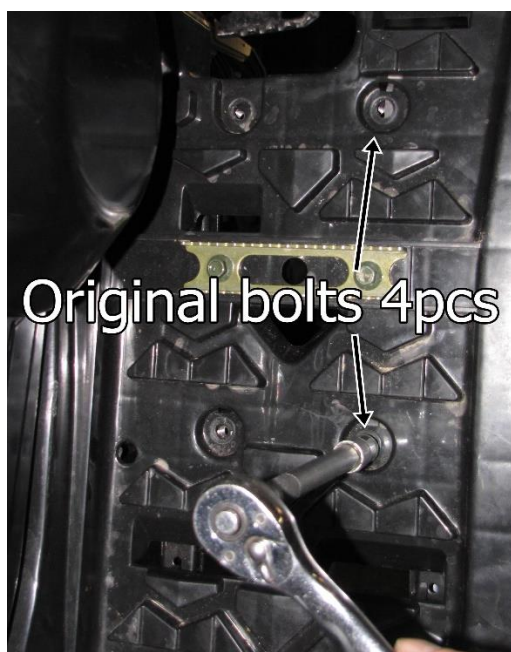

### Samm 3

Paigalda keskosa 02.5001.

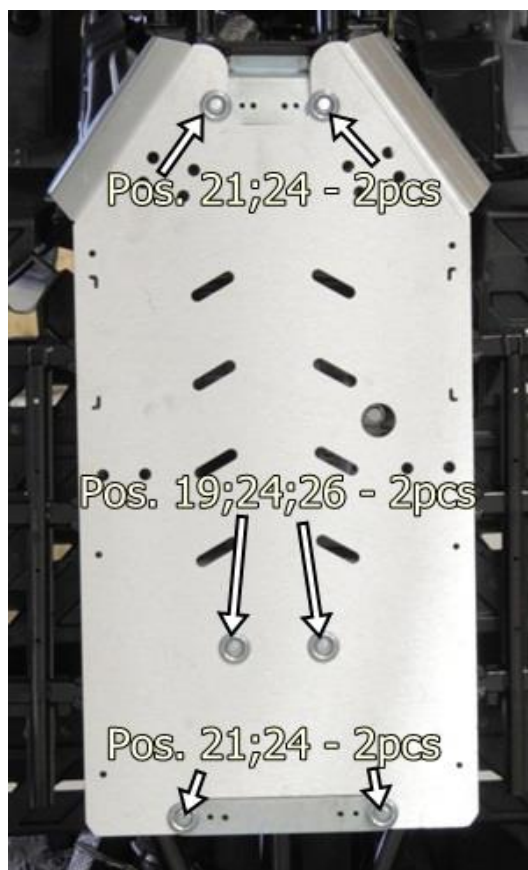

### Samm 4

Paigalda plaadid 02.5006.

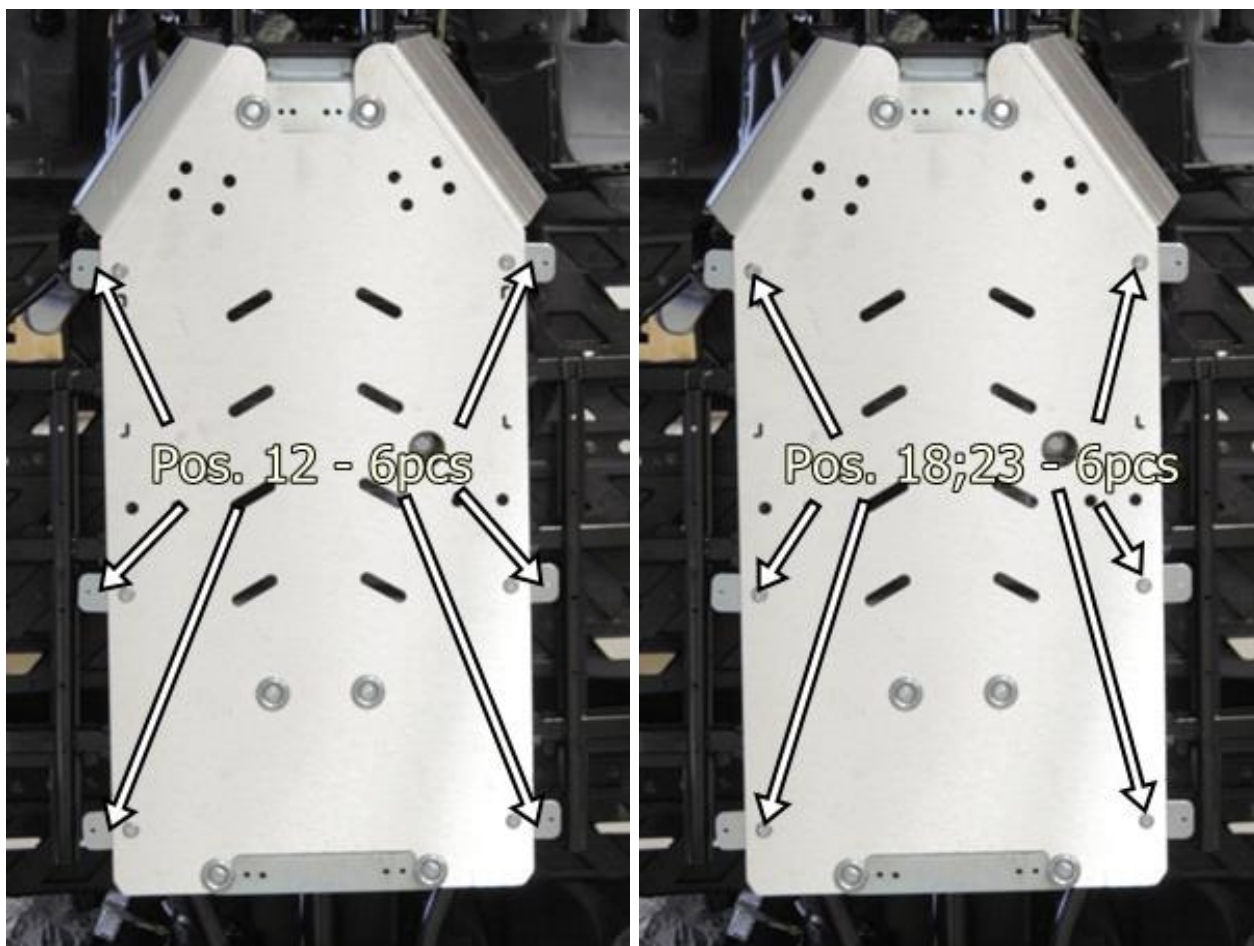

### Samm 5

Paigalda küljekaitsmed 02.5004K, 02.5005K.

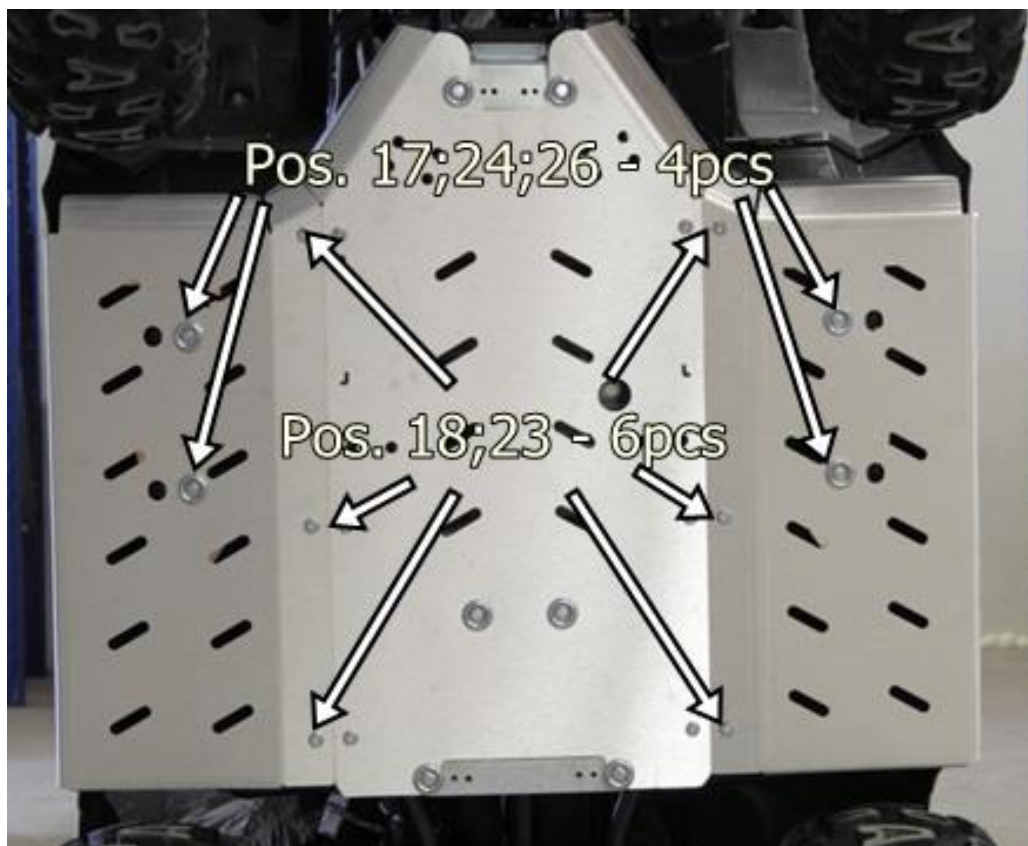

### Samm 6

Paigalda tagaosa 02.5003.

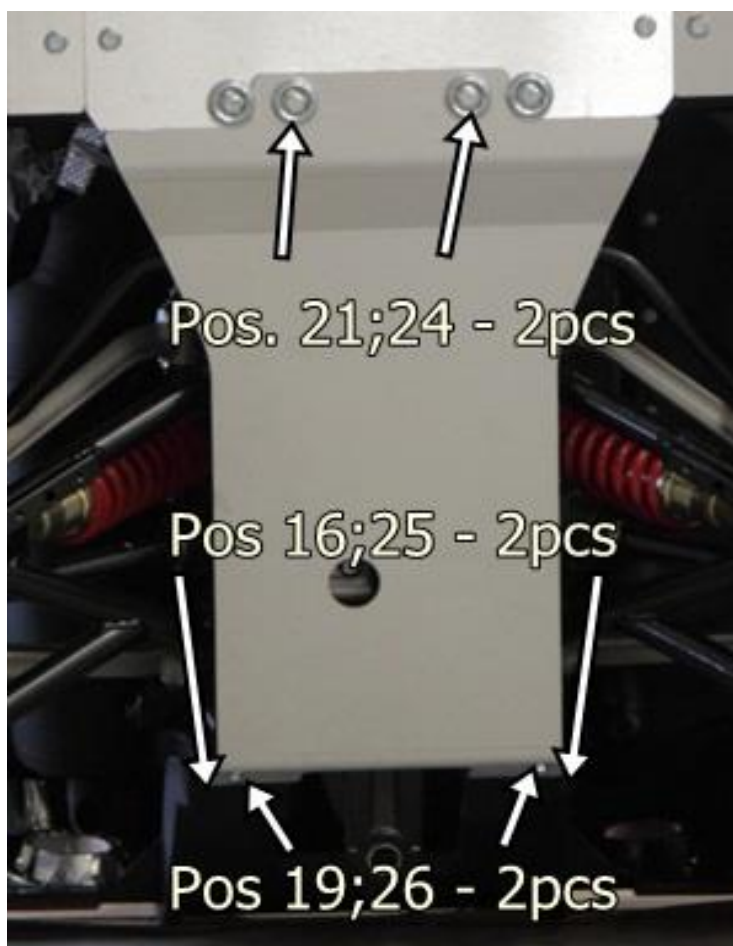

### Samm 7

Paigalda esiosa 02.5002. Paigalda rullik tagasi.

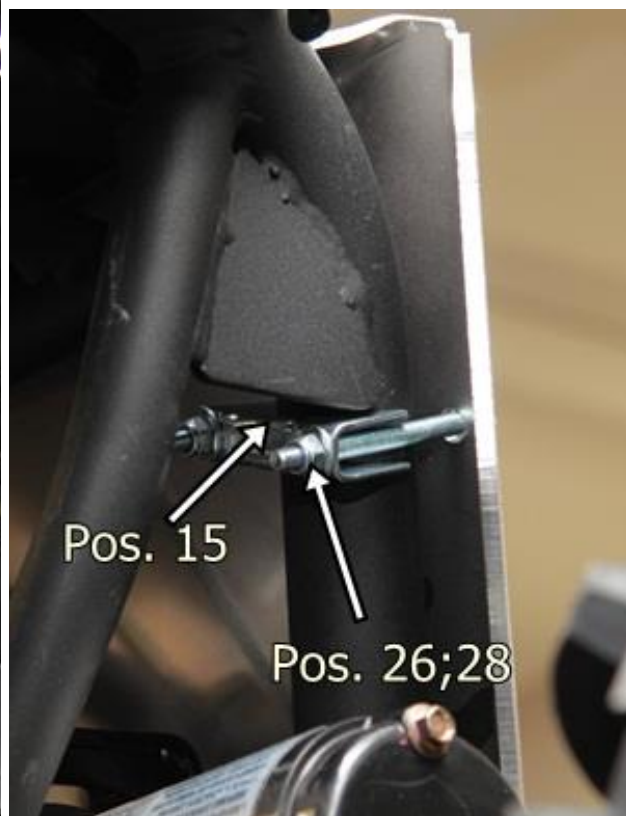
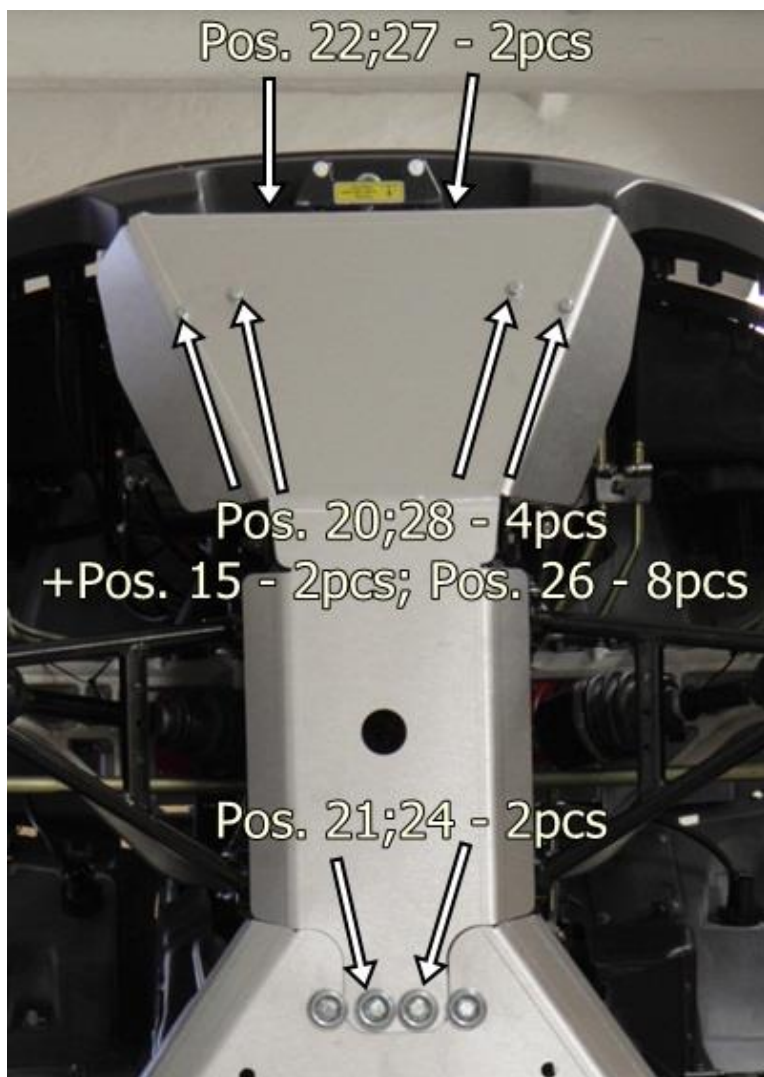

### Samm 8

Paigalda esiõotsahoova kaitsmed 02.1075P+, 02.1075V+.

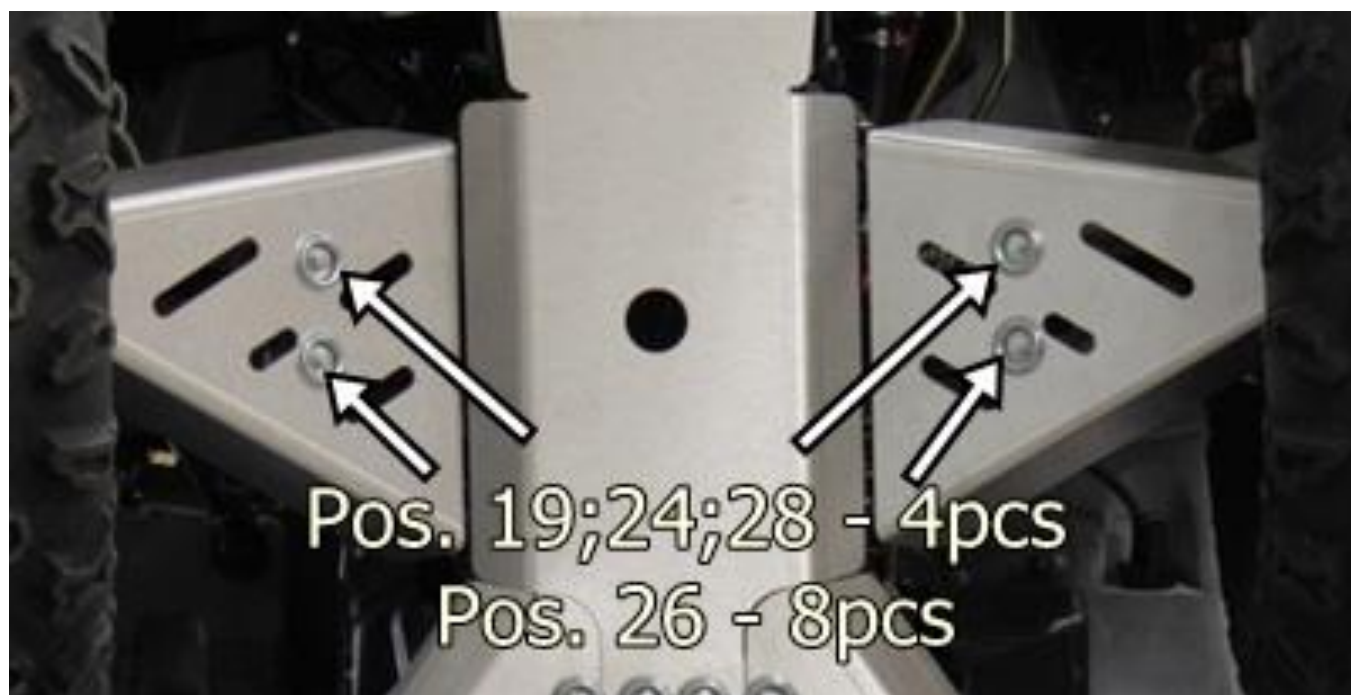

## Samm 9

Paigalda tagaõõtsahoova kaitsmed 02.1076P+, 02.1076V+, kasuta nurkasid 03.1502.

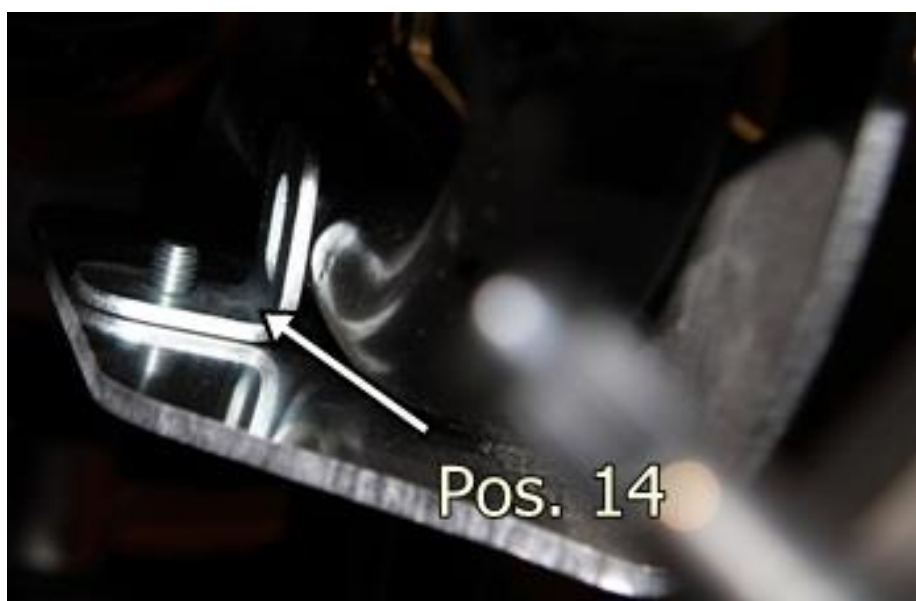
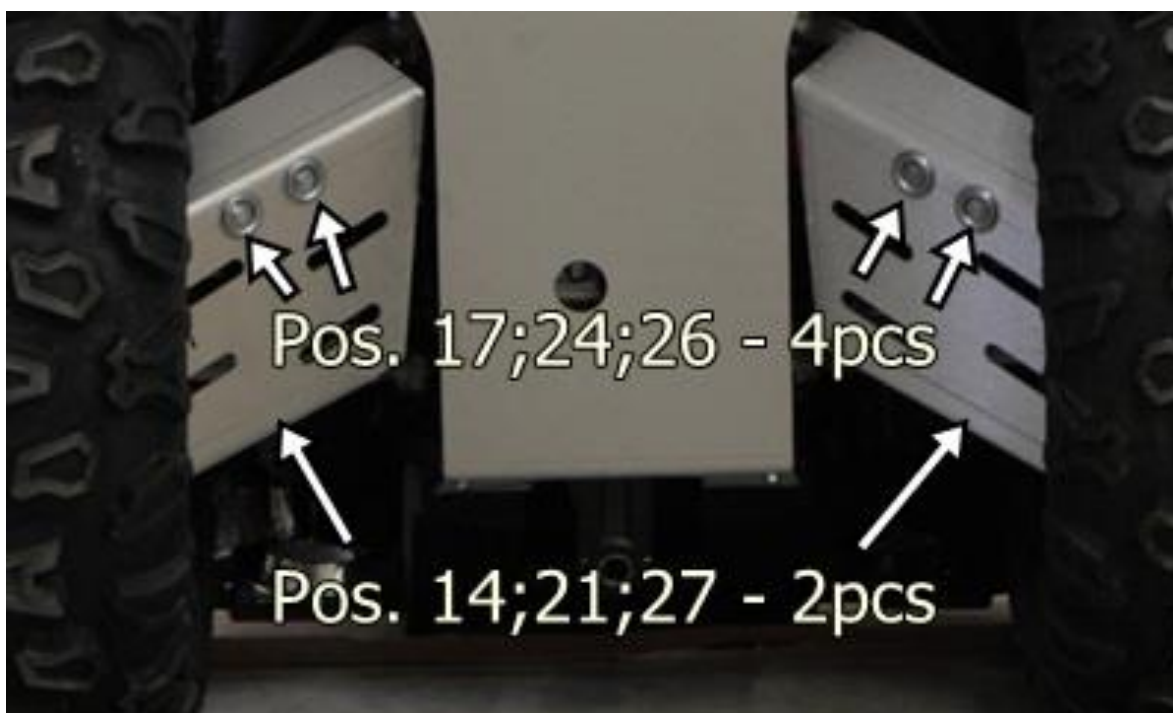







# IRON BALTIC

IRON BALTIC OÜ  
Joa tee 17  
Vääna 76903  
Estonia / Europe

+372 6 533 711  
[sales@ironbaltic.com](mailto:sales@ironbaltic.com)

[www.ironbaltic.com](http://www.ironbaltic.com)  
[www.facebook.com/ironbaltic](https://www.facebook.com/ironbaltic)  
[www.youtube.com/user/ironbalticLtd](https://www.youtube.com/user/ironbalticLtd)

