

IRON BALTIC

SKID PLATE

DINLI

700 DL702 Centhor (model 2010)

Code 02.4400

Version 22102023

DOWNLOAD MULTILINGUAL
USER MANUAL



code.ironbaltic.com/u/hxNGDnSh

Keep this manual for future reference!

If you need any spare parts, please send this packaging data to your local dealer or to Iron Baltic
sales@ironbaltic.com

Iron Baltic Ltd | +372 653 3711 | sales@ironbaltic.com | www.ironbaltic.com

SPECIFICATION

Pos.	Description	Code	Amount
1	Middle part	02.4404	1
2	Right protection	02.4405	1
3	Left protection	02.4406	1
4	Rear part	02.7202	1
5	Front part	02.7203K	1
6	Front right arm protection	02.1983	1
7	Front left arm protection	02.1984	1
8	Rear right arm protection	02.4401K	1
9	Rear left arm protection	02.4402K	1
10	Plate	02.5006	10
11	Clamp M8	03.1502	2
12	Bolt M6x16 DIN 7991	OT.02.04.020	30
13	Bolt M6x25 DIN 7991	OT.02.04.040	4
14	Bolt M6x30 DIN 7991	OT.02.04.050	4
15	Bolt M6x80 DIN 7991	OT.02.04.110	2
16	Bolt M8x16 DIN 7991	OT.02.04.140	2
17	Bolt M8x25 DIN 7991	OT.02.04.160	2
18	Bolt M6x16 DIN 933	OT.02.02.050	2
19	Conical washer Ø6	14.502	42
20	Conical washer Ø8	14.501	4
21	Washer Ø6/15 SFS 3738	OT.04.03.020	2
22	Nyloc nut M6 DIN 985	OT.03.02.030	2
23	Pipe clamp with rubber	Wuerth	2

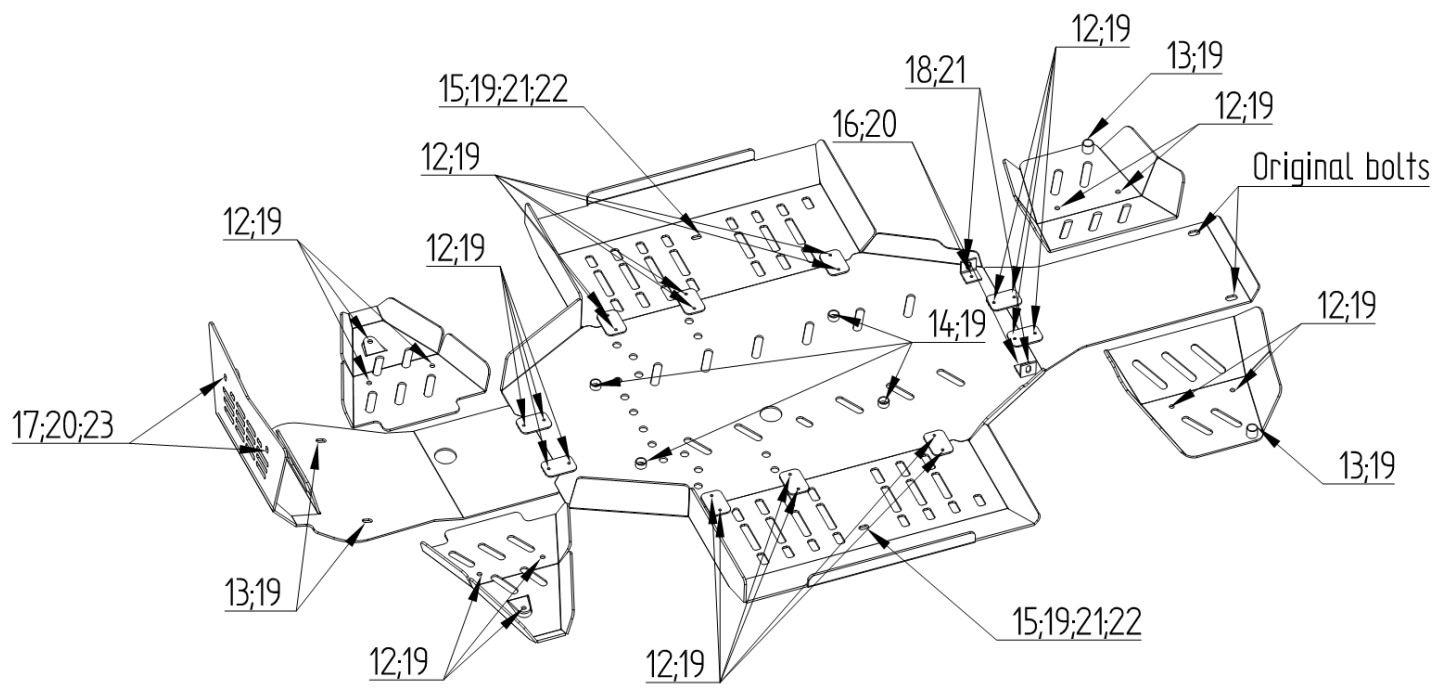
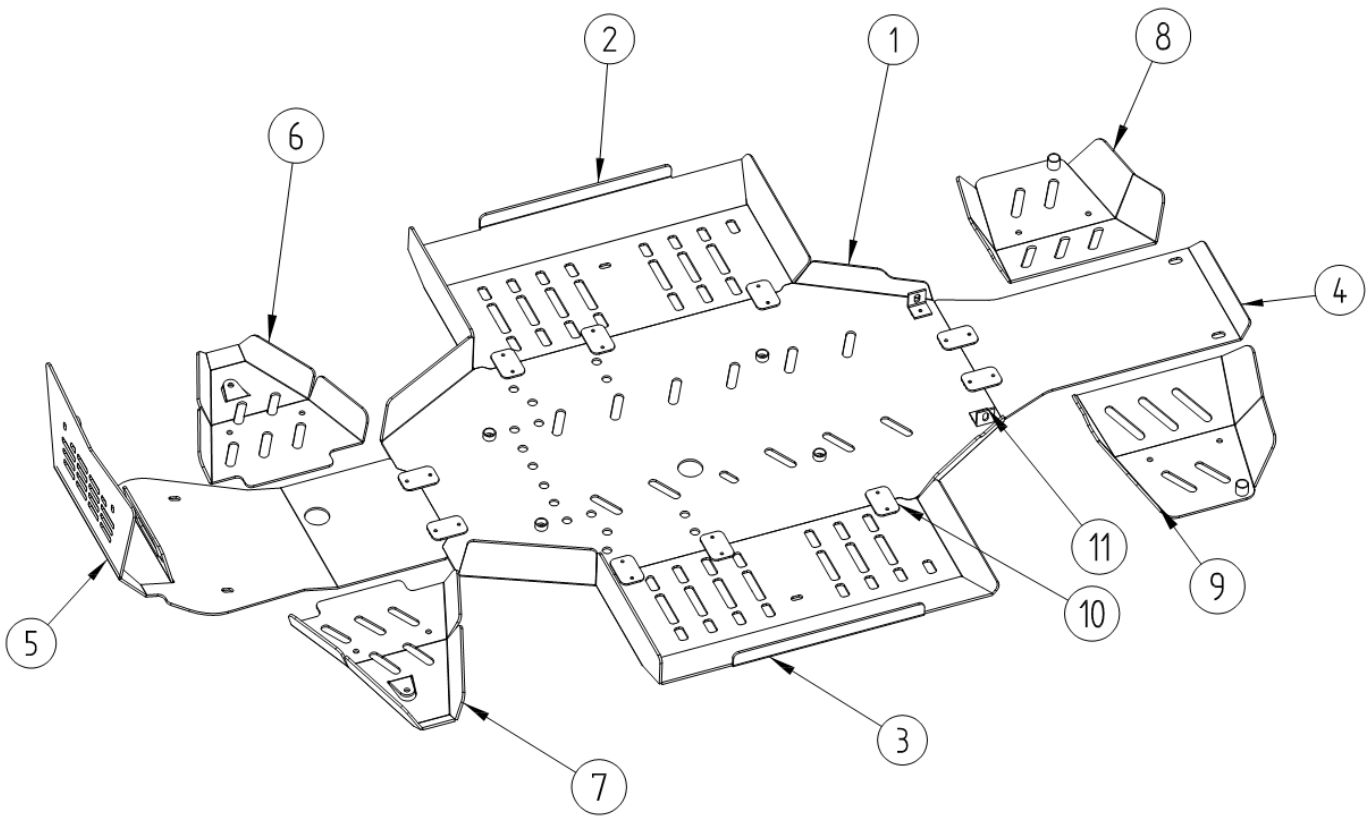

FITTING INSTRUCTIONS

Step 1 Remove all standard plastic covers.

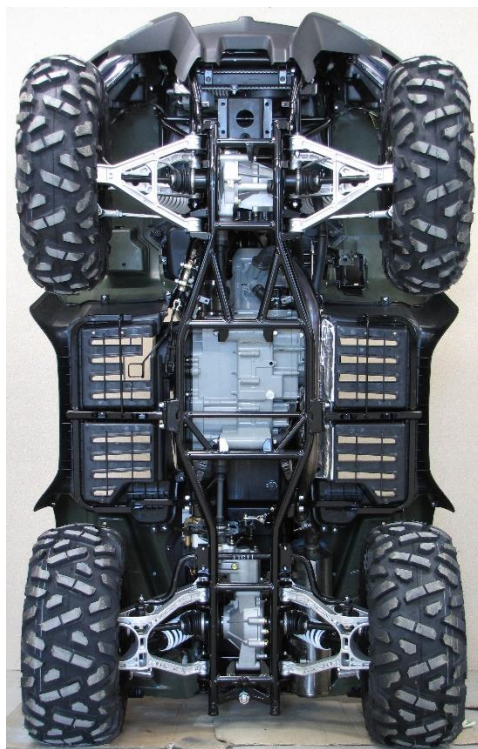

Step 2 Install clamps 02.1504 , use bolts M6x16 (DIN 933).

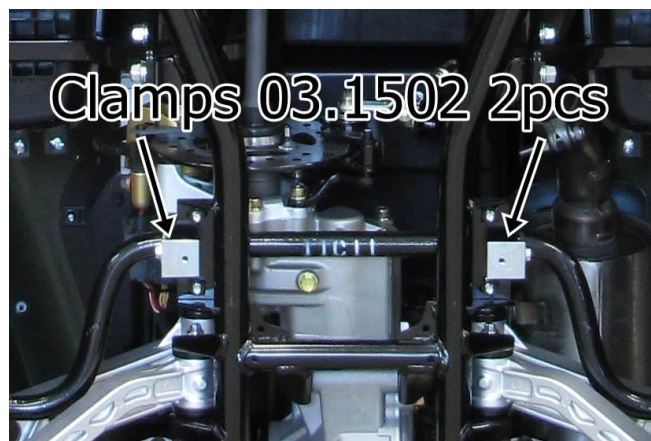

Step 3

Install middle part, use bolts M6x30 and M8x16.



Step 4

Install plates 02.5006 to middle part, use bolts M6x16.

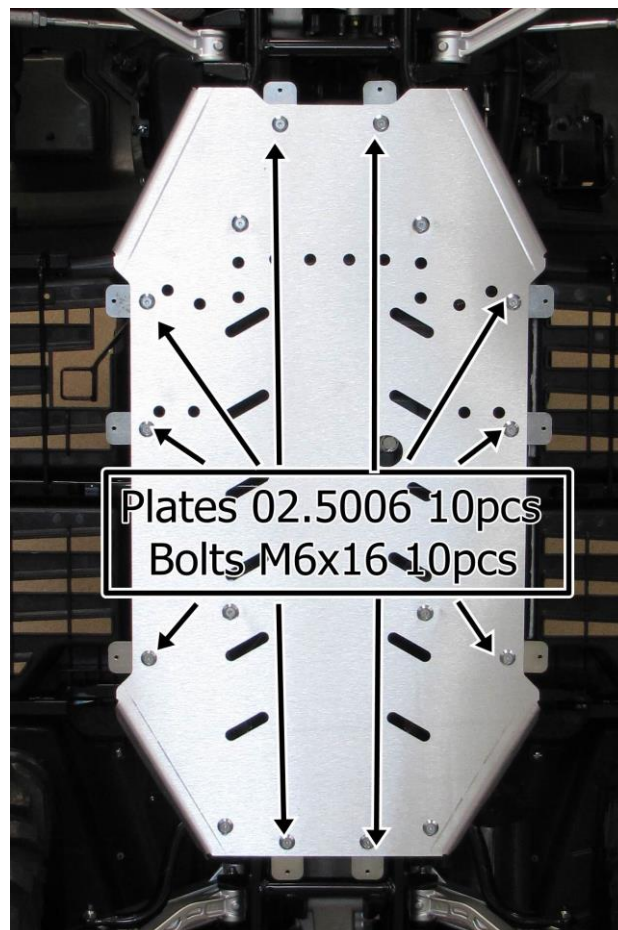

Step 5

Install rear part, use bolts M6x16 and original bolts.

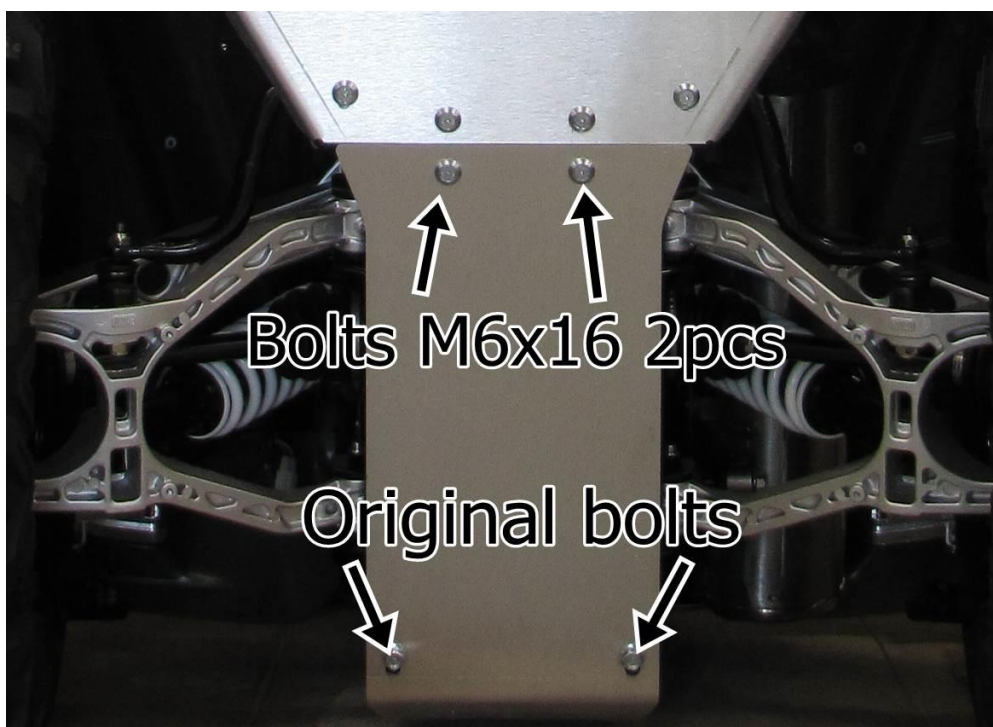

Step 6

Install front part, use bolts M6x16, M6x25, M8x25 and pipe clamps.

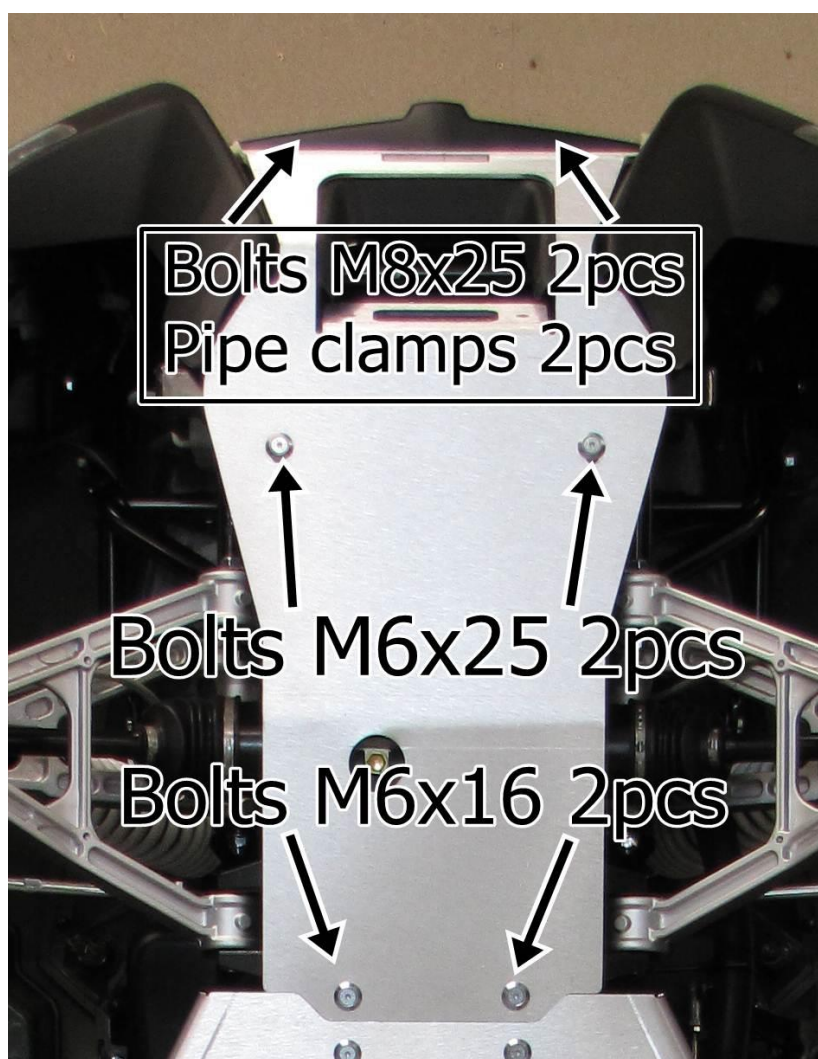

Step 7

Install side protections, use bolts M6x16, M6x80 and nyloc nuts.

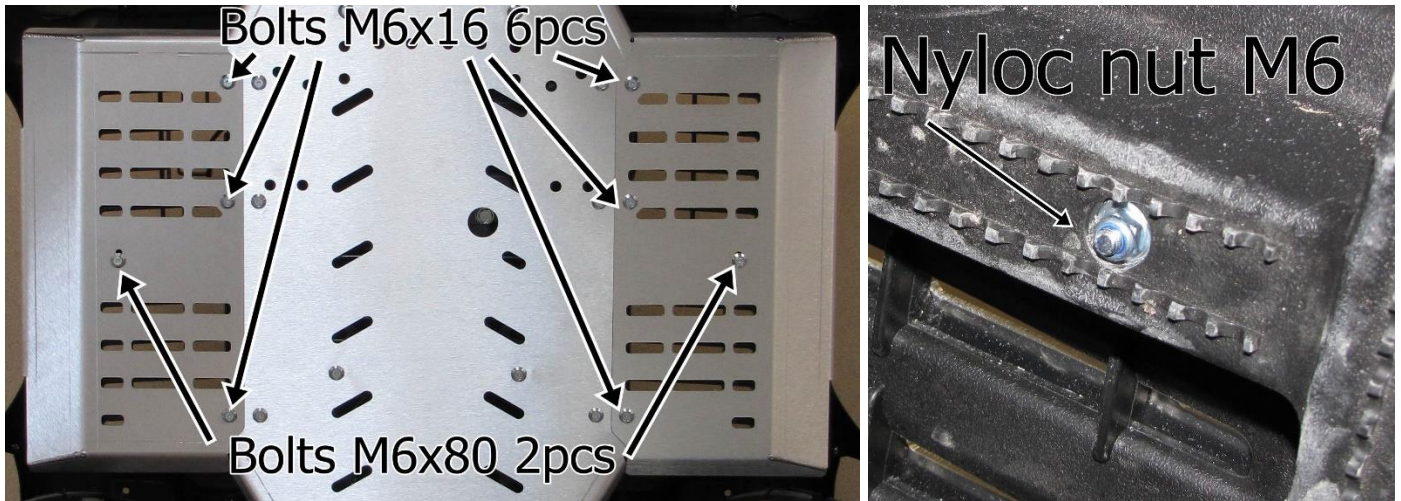

Step 8

Install front arms protections, use bolts M6x16.

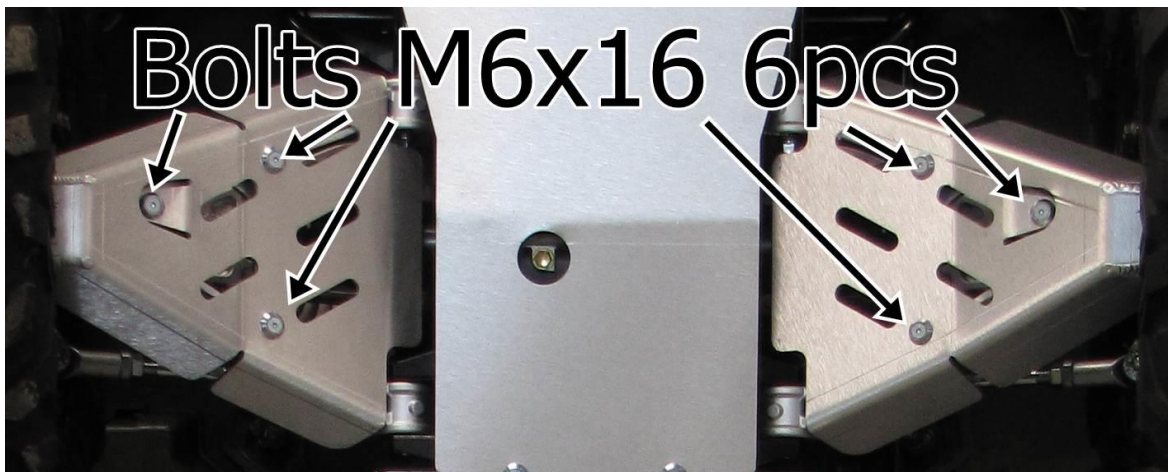

Step 9

Install rear arms protections, use bolts M6x16 and M6x25.



IRON BALTIC

IRON BALTIC OÜ
Joa tee 17
Vääna 76903
Estonia / Europe

+372 6 533 711
sales@ironbaltic.com

www.ironbaltic.com
www.facebook.com/ironbaltic
www.youtube.com/user/ironbalticLtd

