

IRON BALTIC

PLASTIK PÕHJAKAITSE

GOES

Iron/ Cobalt (MAX)

Kood 02.19700

Version 11092023

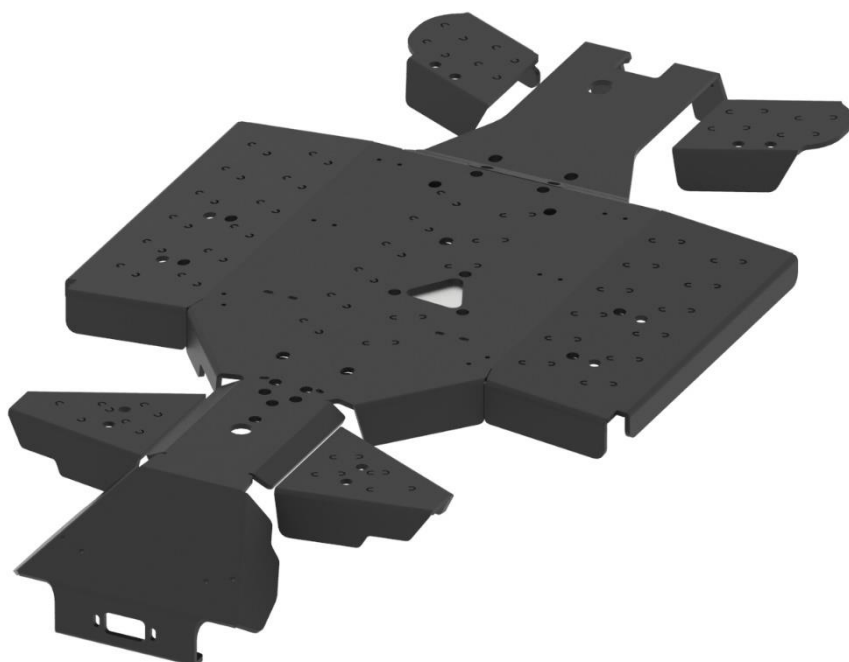

Hoidke käesolev juhend alles edaspidiseks kasutamiseks!

Varuosade soovi korral esitage käesoleva lehe koopia või ülal märgitud andmed sõiduki margi, mudeli ja toote seerianumbrite kohta toote müüjale või tootjale aadressile sales@ironbaltic.com

Iron Baltic Ltd | +372 653 3711 | sales@ironbaltic.com | www.ironbaltic.com

DOWNLOAD MULTILINGUAL
USER MANUAL

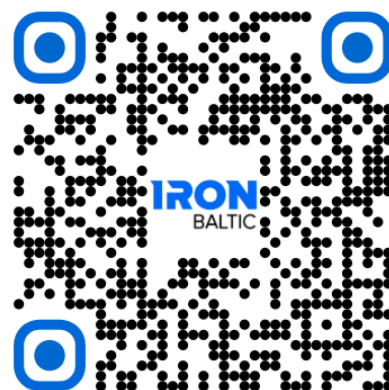

code.ironbaltic.com/u/u19yyISB

SPETSIFIKATSIOON

Pos.	Nimetus	Kood	Kogus
1	Põhjakaitsme keskosa	02.19701K	1
2	Põhjakaitsme esiosa	02.19702	1
3	Põhjakaitsme tagaos	02.19703K	1
4	Vasakpoolne esiõõtsuova kaitse	02.1137V+	1
5	Parempoolne esiõõtsuova kaitse	02.1137P+	1
6	Vasakpoolne tagaõõtsuova kaitse	02.1138V+	1
7	Parempoolne tagaõõtsuova kaitse	02.1138P+	1
8	Parempoolne küljekaitse	02.11004	1
9	Vasakpoolne küljekaitse	02.11005	1
10	Õliava kaas	02.15006	1
11	Esiosa klamber	02.19604	1
12	Kinnitusplaat	02.718	3
13	Plaat	02.5006	8
14	Kronstein	02.6408	4
15	Plaat (20)	02.8311	2
16	Nurk	03.1502	2
17	Klambri vastus 38mm	OT.05.04.030	2
18	Nõgus seib	14.503	32
19	Kruvi 4,8x25 DIN 7504-K	OT.01.02.055	2
20	Polt M6x16 DIN 933	OT.02.02.050	22
21	Polt M6x25 DIN 933	OT.02.02.070	7
22	Polt M6x45 DIN 933	OT.02.02.110	4
23	Polt M6x55 DIN 933	OT.02.02.130	2
24	Polt M6x65 DIN 933	OT.02.02.145	4
25	Polt M8x30 DIN 933	OT.02.02.200	2
26	Polt M6x20 DIN 7991	OT.02.04.030	12
27	Polt M6x25 DIN 7991	OT.02.04.040	2
28	Polt M8x25 DIN 7991	OT.02.04.160	2
29	Koonuseib Ø6	14.502	14
30	Koonuseib Ø8	14.501	2
31	Seib Ø5/15 DIN 9021	OT.04.02.010	2
32	Seib Ø6/15 SFS 3738	OT.04.03.020	47
33	Seib Ø8/20 SFS 3738	OT.04.03.030	2
34	Nyloc mutter M6 DIN 985	OT.03.02.030	8

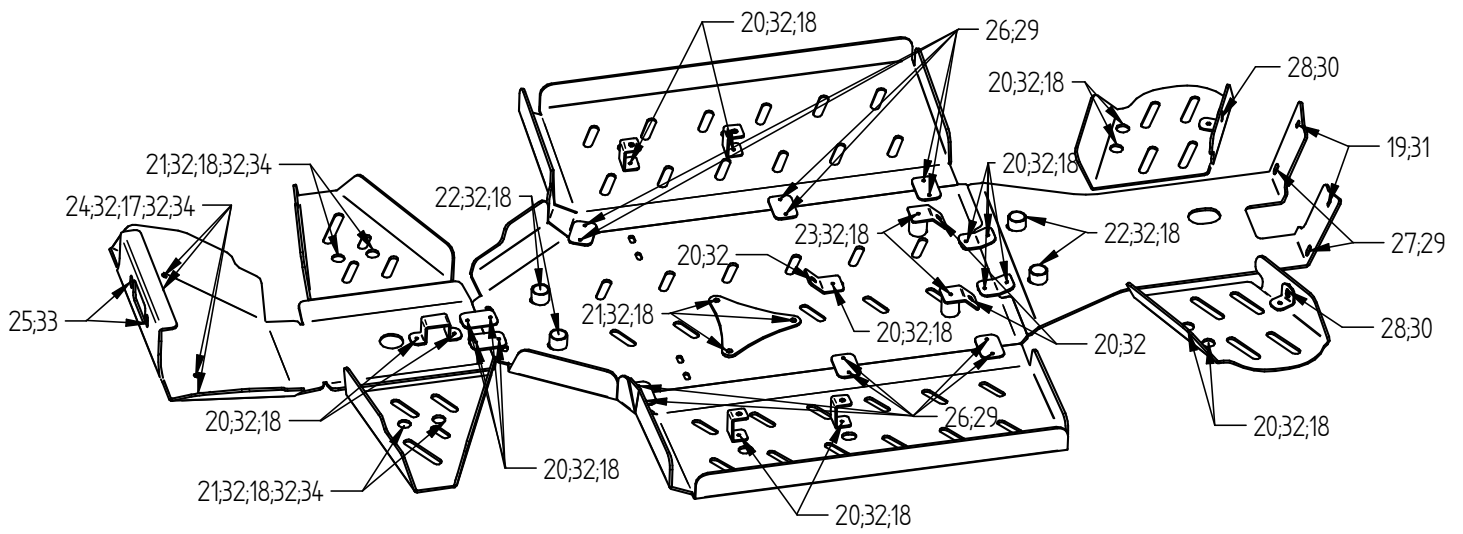
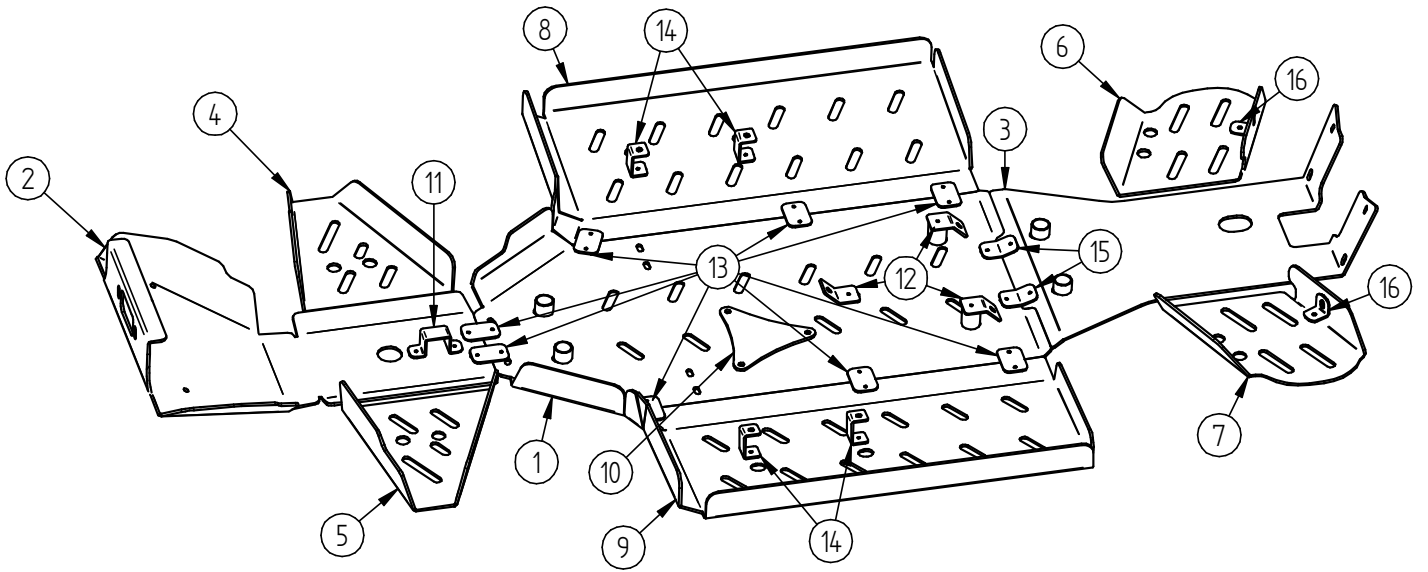

PAIGALDUSJUHEND

Samm 1

Eemalda originaal plastikkaitse ja rullik.

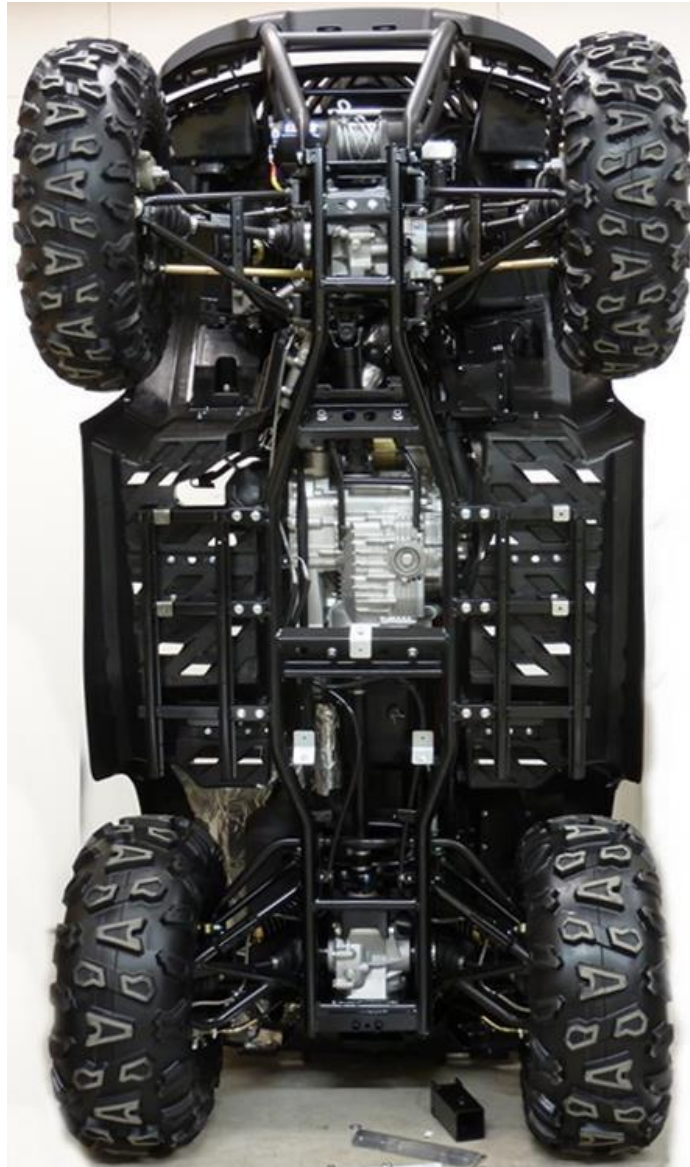

Samm 2

Paigalda kinnitusplaadid 02.718 ja 02.6408.

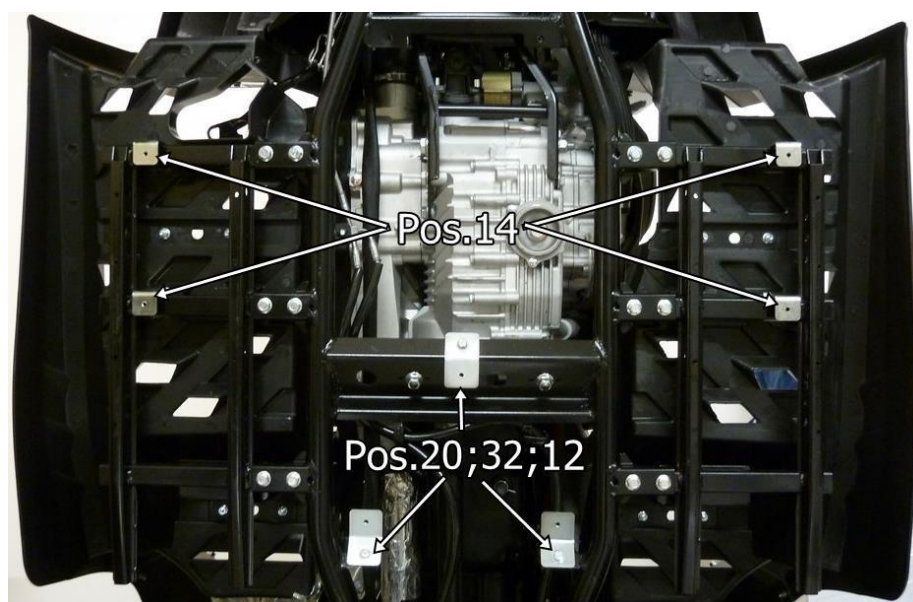

Samm 3

Paigalda esiõõtshoova kaitsmed 02.1137V+ ja 02.1137P+.

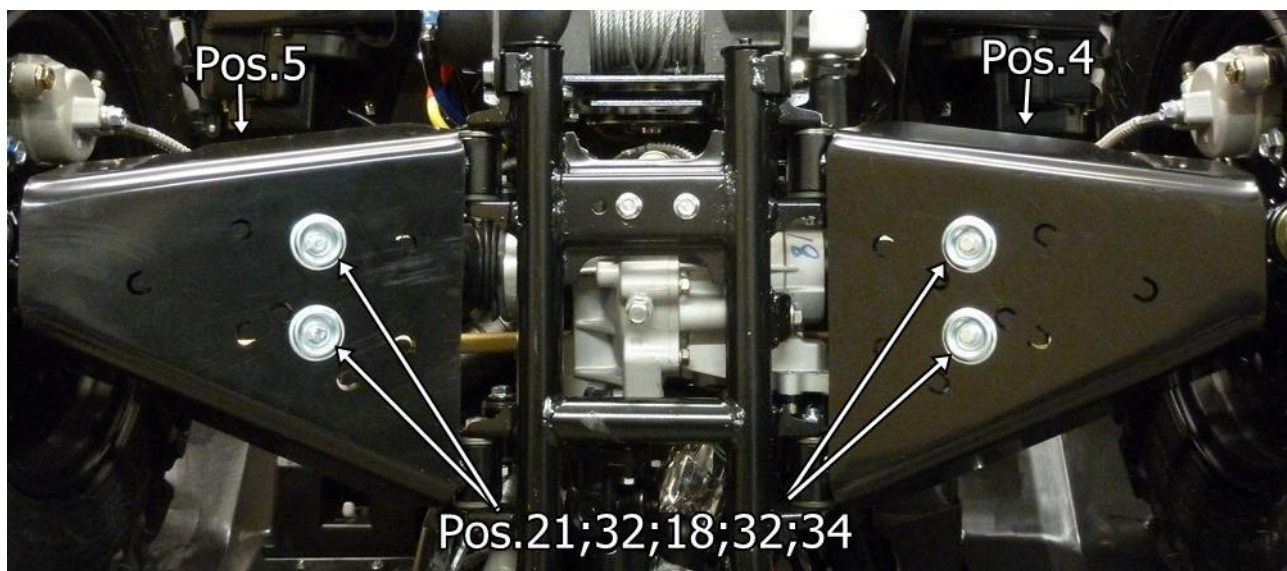

Samm 4

Paigalda tagaõõtshoova kaitsmed 02.1138V+ ja 02.1138P+.

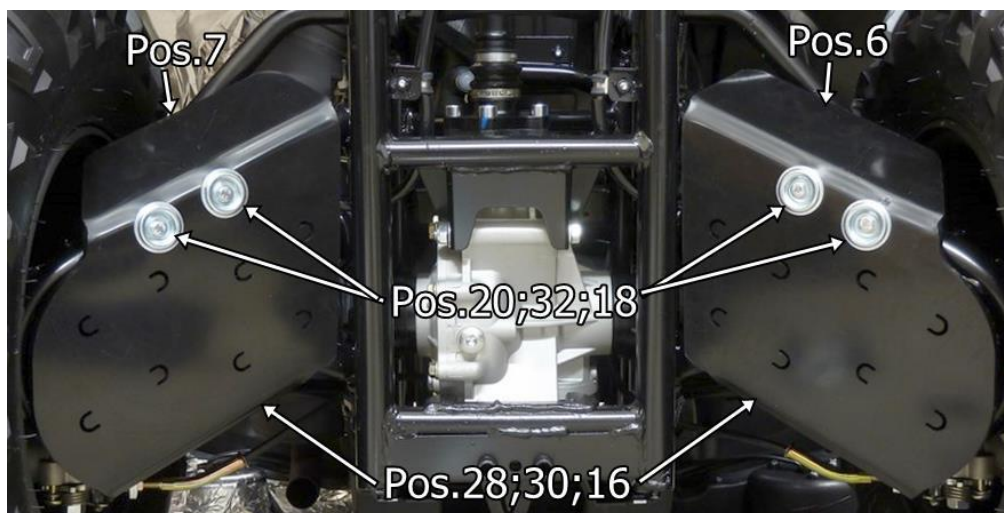

Samm 5

Paigalda õliava kaas 02.15006 keskosale ja põhjakaitse keskmine osa 02.19601K.



Samm 6

Paigalda plaadid 02.5006 ja 02.8311 keskosale.

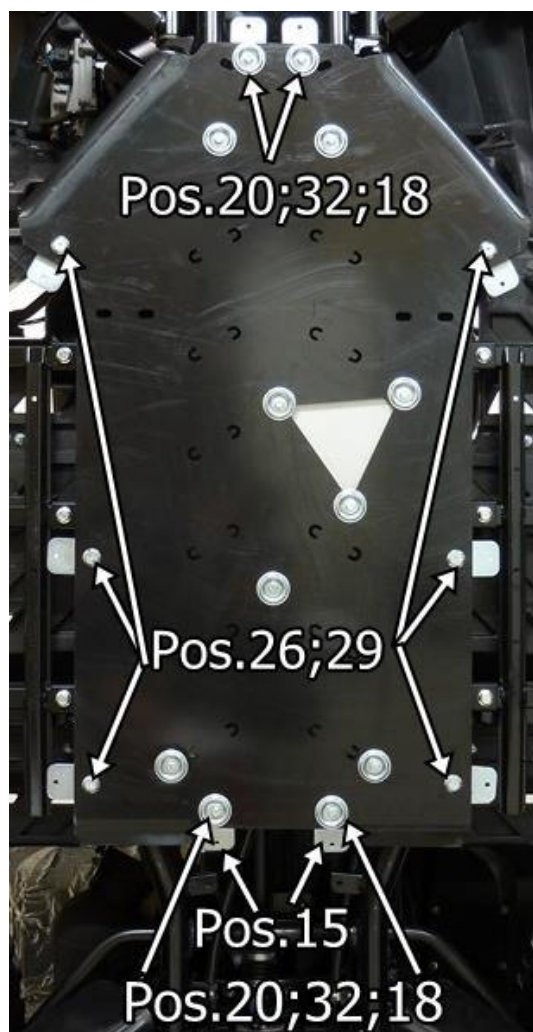

Samm 7

Paigalda tagaos 02.19703K.

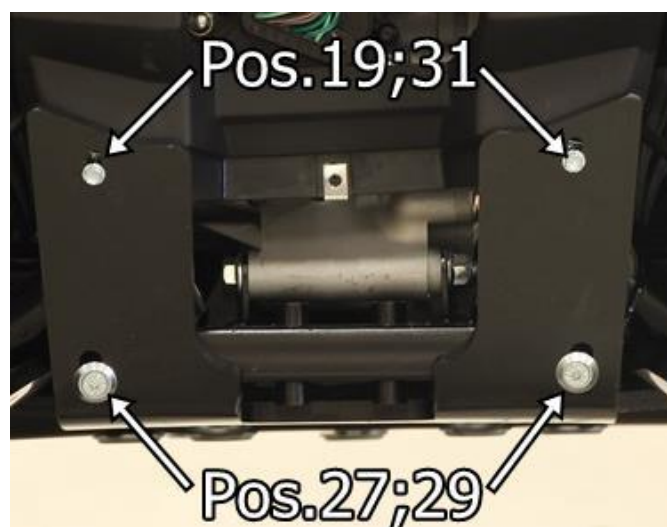
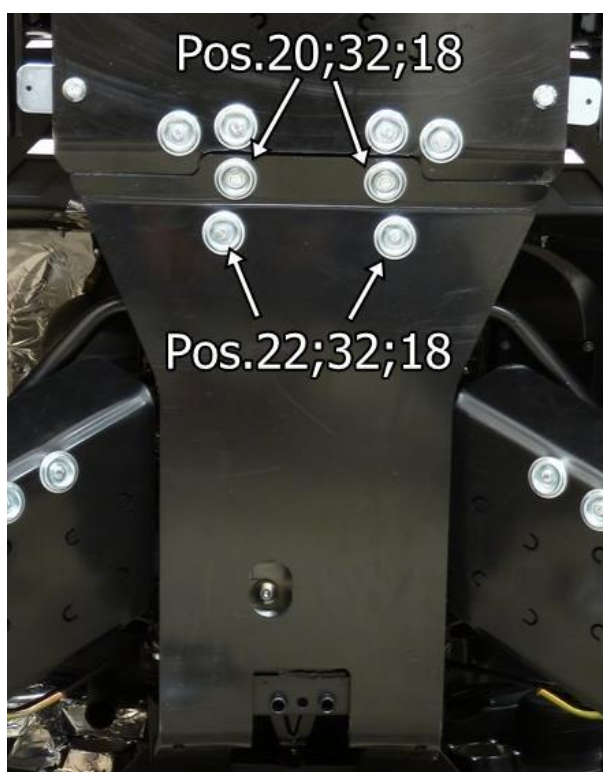

Samm 8

Paigalda esiosa kaitse 02.19702.

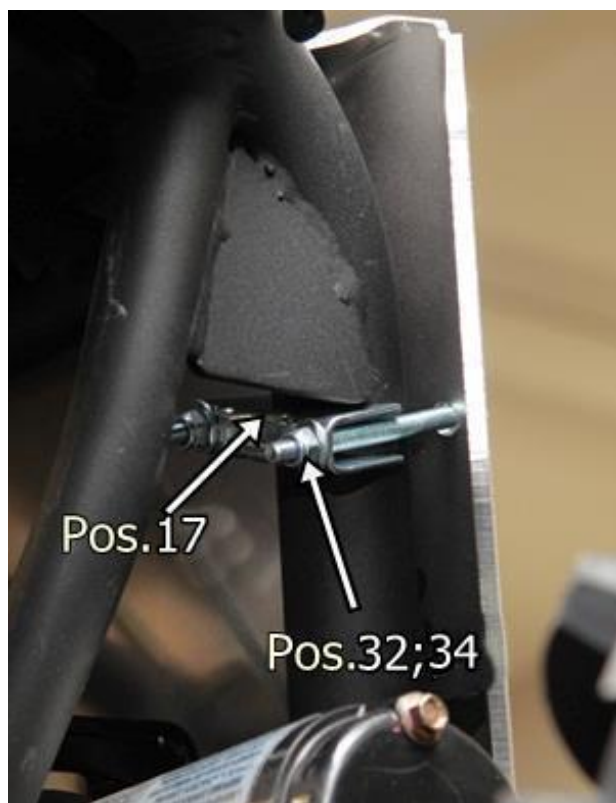

Samm 9

Paigalda küljekaitsmed 02.11004 ja 02.11005.

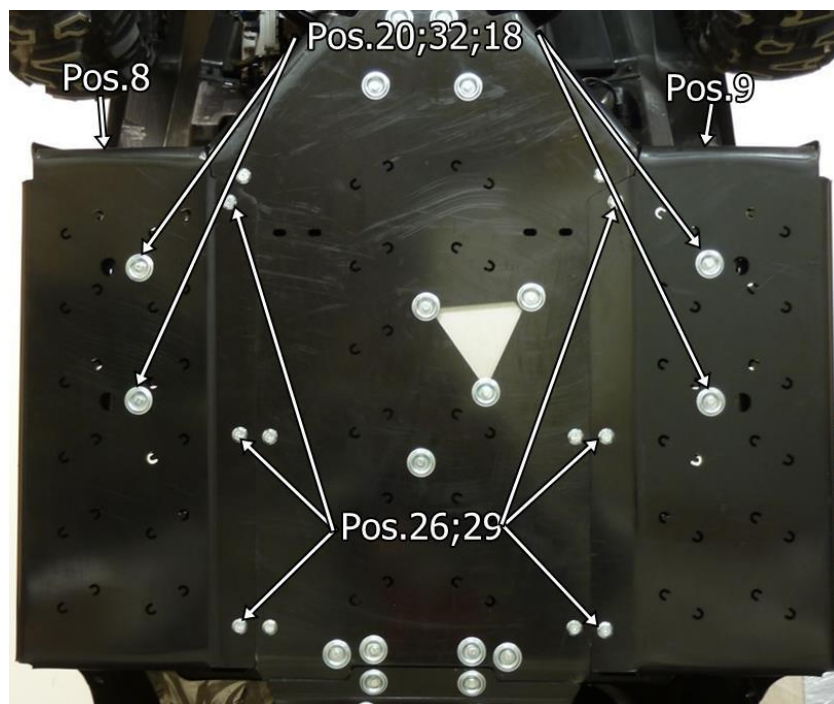

Samm 10

Õliava plaadi avamiseks eemalda kaks noolega näidatud polti ja keera kolmas polt pooleldi välja. Lükka plaat eemale.

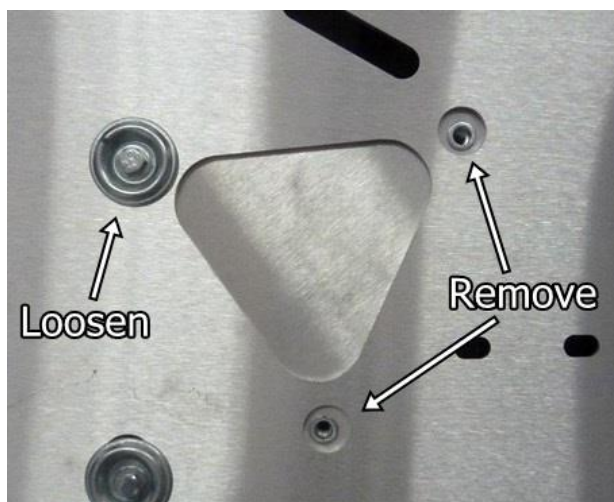

IRON BALTIC

IRON BALTIC OÜ
Joa tee 17
Vääna 76903
Estonia / Europe

+372 6 533 711
sales@ironbaltic.com

www.ironbaltic.com
www.facebook.com/ironbaltic
www.youtube.com/user/ironbalticLtd

