

IRON BALTIC

ALUMIINIUM PÕHJAKAITSE

DOWNLOAD MULTILINGUAL
USER MANUAL



code.ironbaltic.com/u/7fDoAGvQ

SMC

J-Max 700 L

Kood 02.15400

Version 01092023

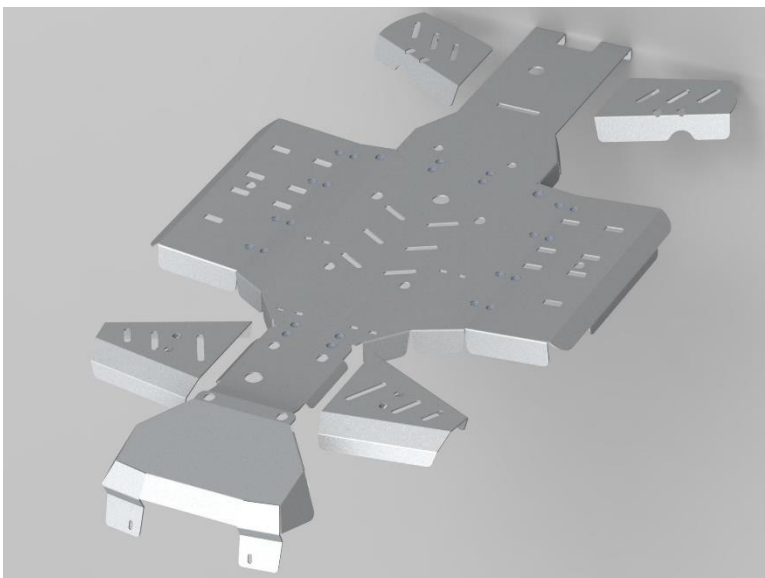

Hoidke käesolev juhend alles edaspidiseks kasutamiseks!

Varuosade soovi korral esitage käesoleva lehe koopia või ülal märgitud andmed sõiduki margi, mudeli ja toote seerianumbrite kohta toote müüjale või tootjale aadressile sales@ironbaltic.com

Iron Baltic Ltd | +372 653 3711 | sales@ironbaltic.com | www.ironbaltic.com

SPETSIFIKATSIOON

Pos.	Nimetus	Kood	Kogus
1	Põhjakaitse esimene osa	02.15201	1
2	Põhjakaitse keskosa	02.15402	1
3	Põhjakaitse tagaos	02.15403	1
4	Parempoolne küljekaitse	02.15404	1
5	Vasakpoolne küljekaitse	02.15405	1
6	Vasakpoolne eesiõõtshoova kaitse	02.15206	1
7	Parempoolne esiõõtshoova kaitse	02.15207	1
8	Vasakpoolne tagaõõtshoova kaitse	02.15208	1
9	Parempoolne tagaõõtshoova kaitse	02.15209	1
10	Esiõõtshoova klamber	02.15210	2
11	Kinnitus plaat	02.5006	4
12	Kinnitus plaat	02.8312	8
13	Kronstein	03.1502	2
14	Kinnitusklamber	02.5709	2
15	Nõgus seib	14.503	46
16	Polt M6x12 DIN 933	OT.02.02.030	20
17	Polt M6x14 DIN 933	OT.02.02.040	8
18	Polt M6x20 DIN 933	OT.02.02.060	4
19	Polt M6x25 DIN 933	OT.02.02.070	8
20	Polt M6x30 DIN 933	OT.02.02.080	2
21	Polt M6x55 DIN 933	OT.02.02.130	2
22	Polt M8x16 DIN 933	OT.02.02.170	2
23	Polt M6x20 DIN 7991	OT.02.04.030	2
24	Polt M6x25 DIN 7991	OT.02.04.040	2
25	Polt M8x20 DIN 7991	OT.02.04.150	2
26	Koonusseib Ø6	14.502	4
27	Koonusseib Ø8	14.501	2
28	Seib Ø6/15 SFS 3738	OT.04.03.020	48
29	Seib suur Ø6/18 DIN 9021	OT.04.02.020	2
30	Nyloc mutter M6 DIN 985	OT.03.02.030	6

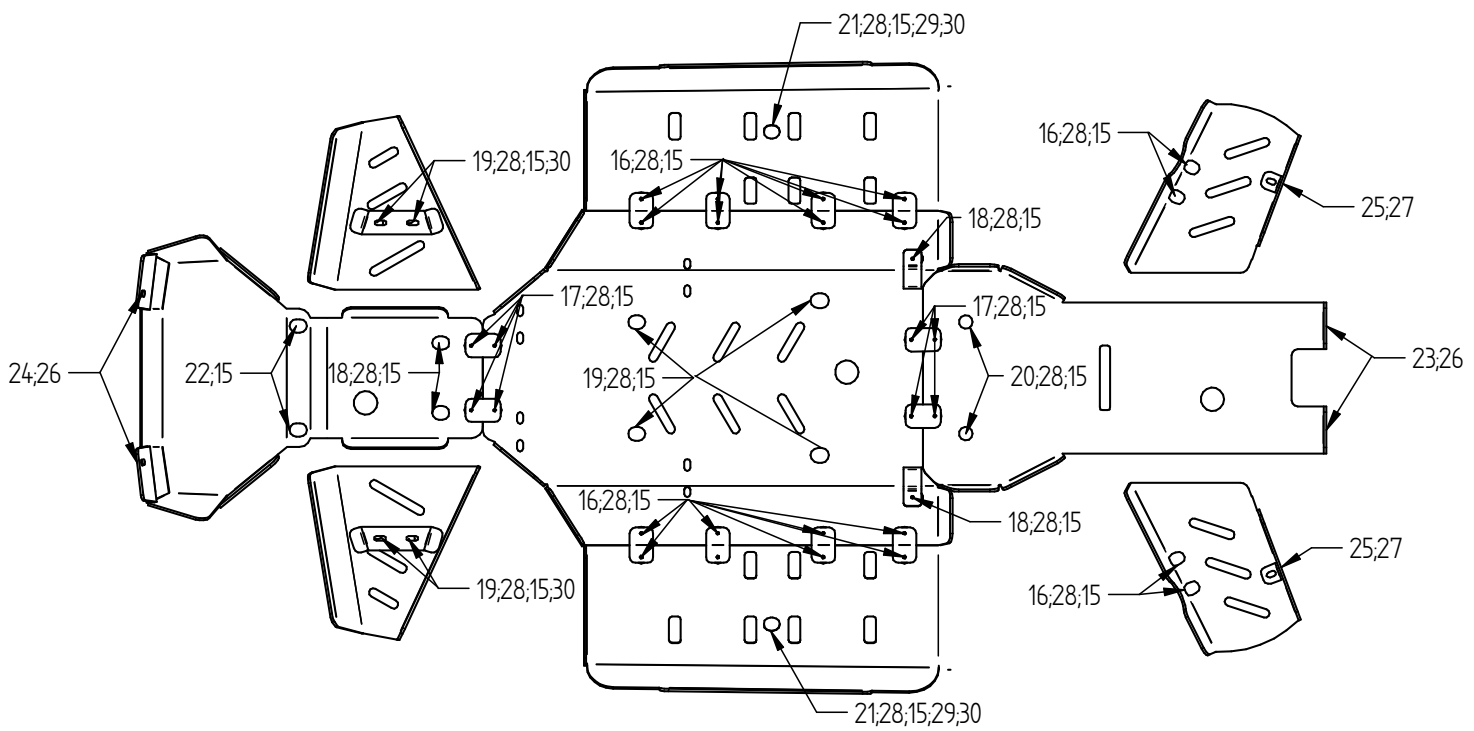
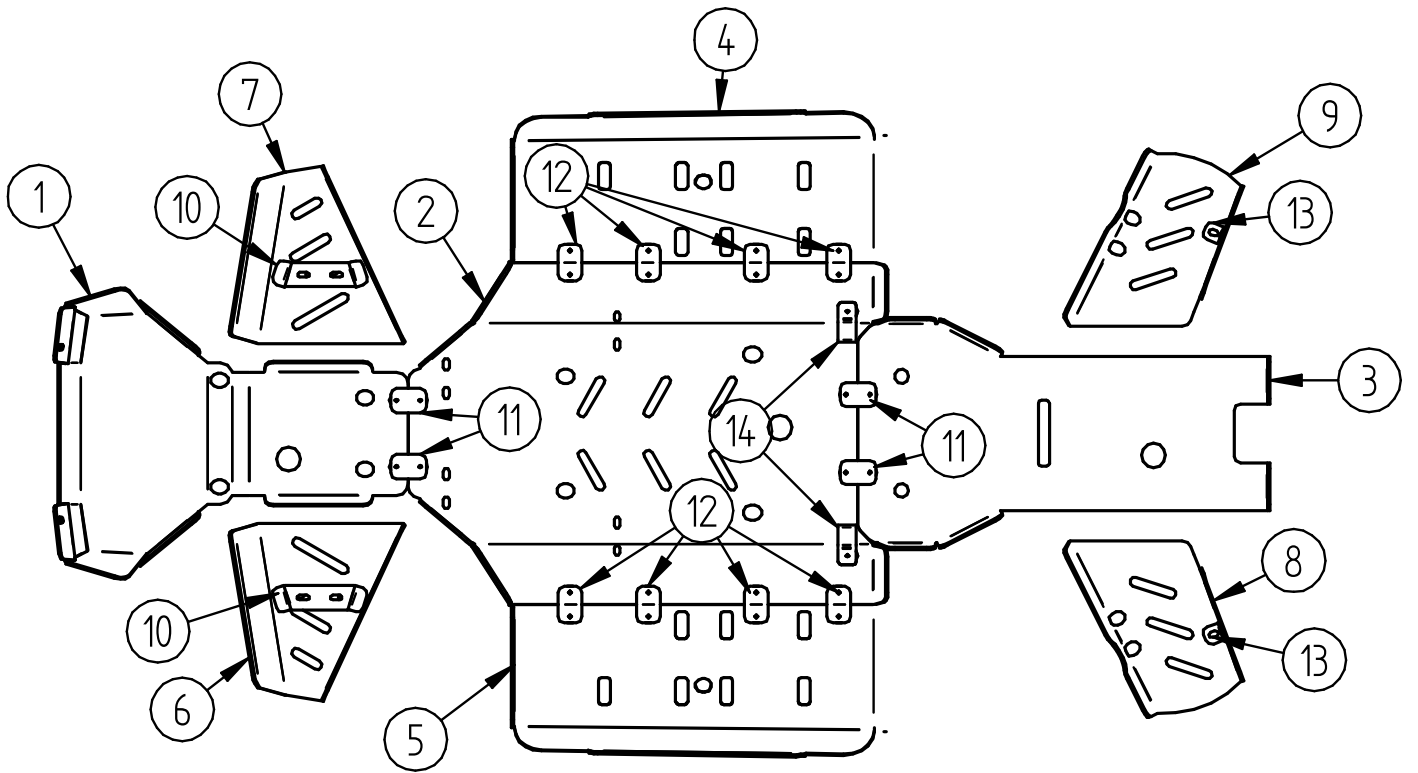

PAIGALDUSJUHEND

Samm 1 Eemalda originaal plastikkaitssmed.



Samm 2 Paigalda esiõõtshoova kaitsmed 02.15206 ja 02.15207.

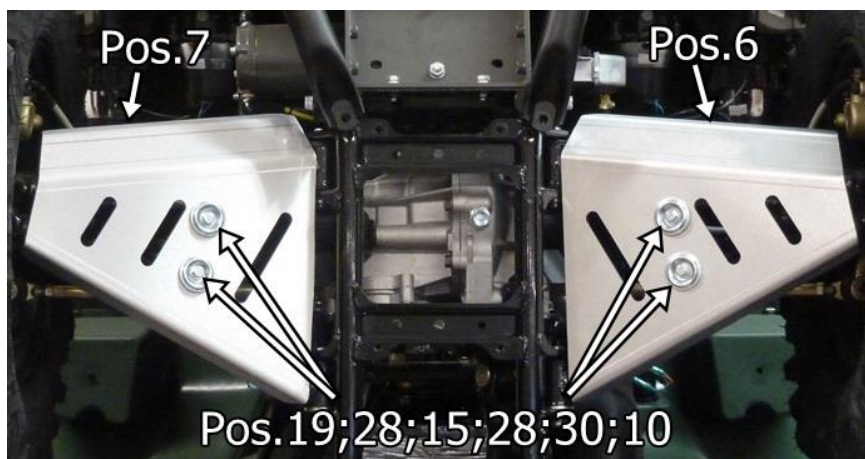

Samm 3

Paigalda tagaõõtshoovakaitsmed 02.15208 ja 02.15209.

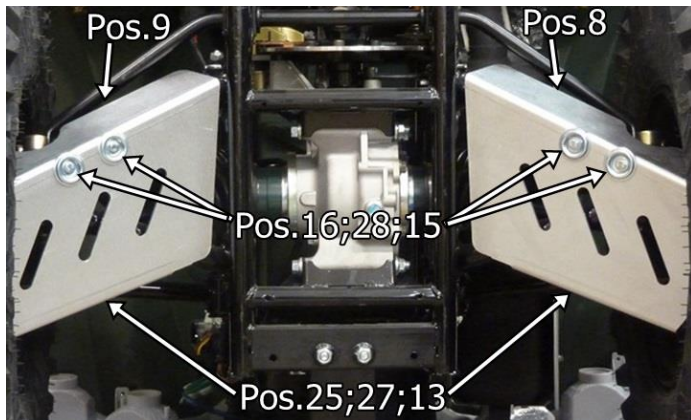

Samm 4

Paigalda põhjakaitsme esimene osa 02.15201 ja plaadid 02.5006. Kui ATV on varustatud kaitseraudadega siis kasuta M8x16 polti ilma nõgusa seibita.

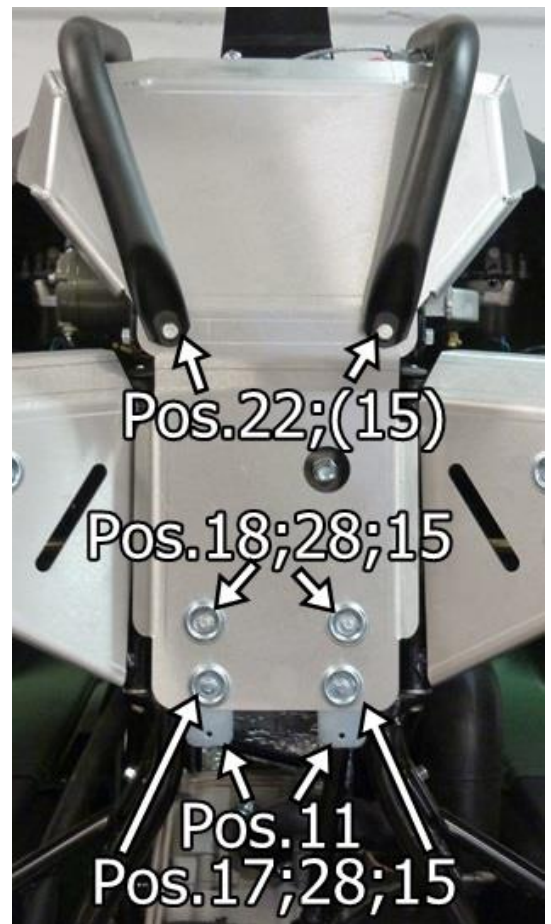
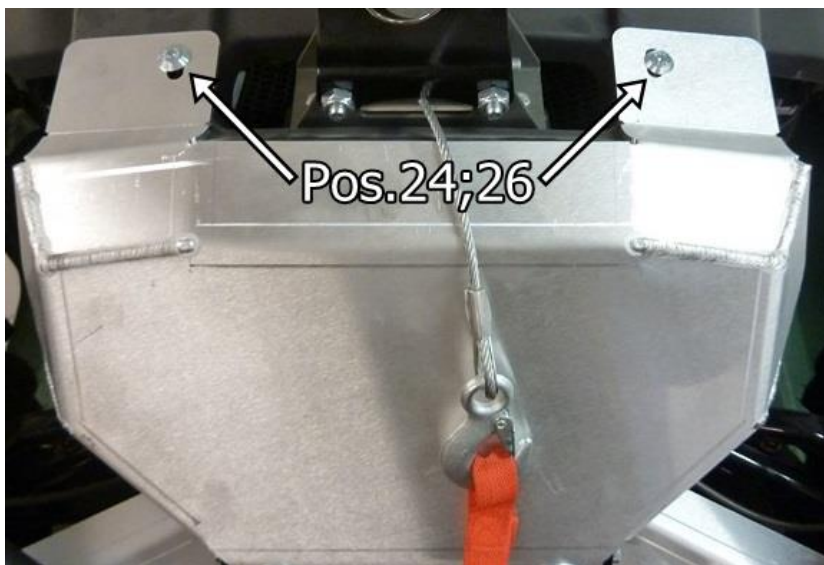

Samm 5 Paigalda põhjakaitse keskmine osa 02.15402.

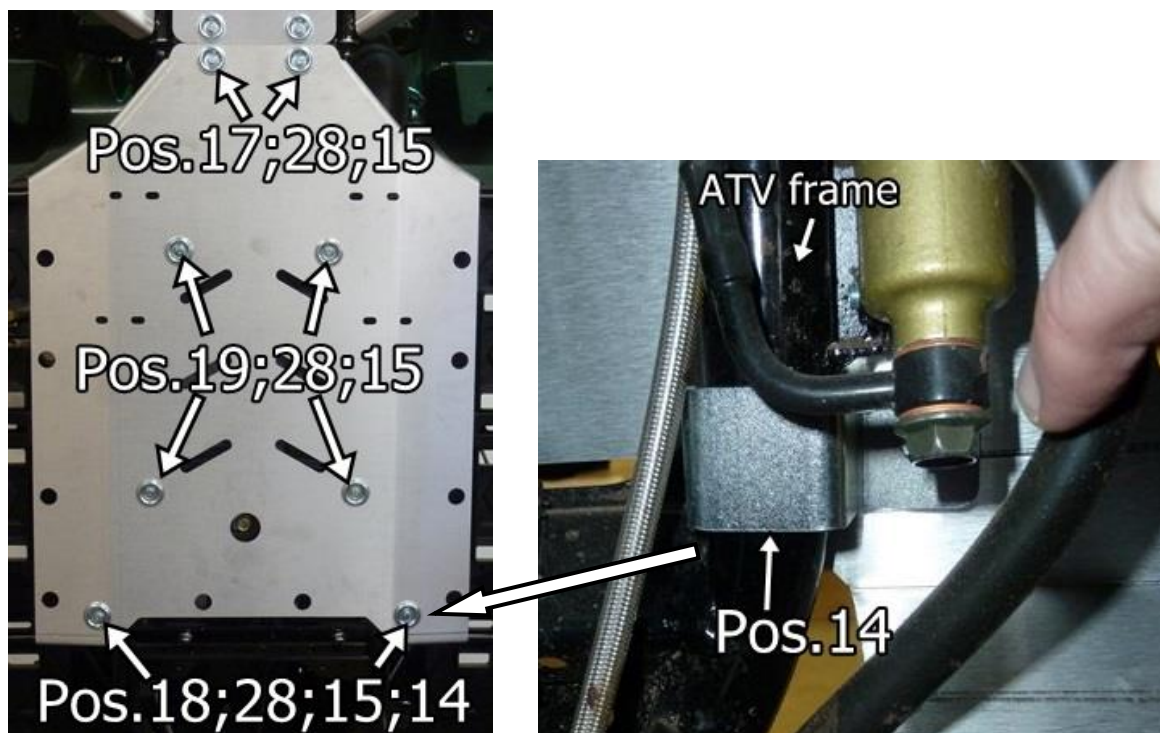

Samm 6 Paigalda põhjakaitse keskmisele osale plaadid 02.5006 ja 02.8312.

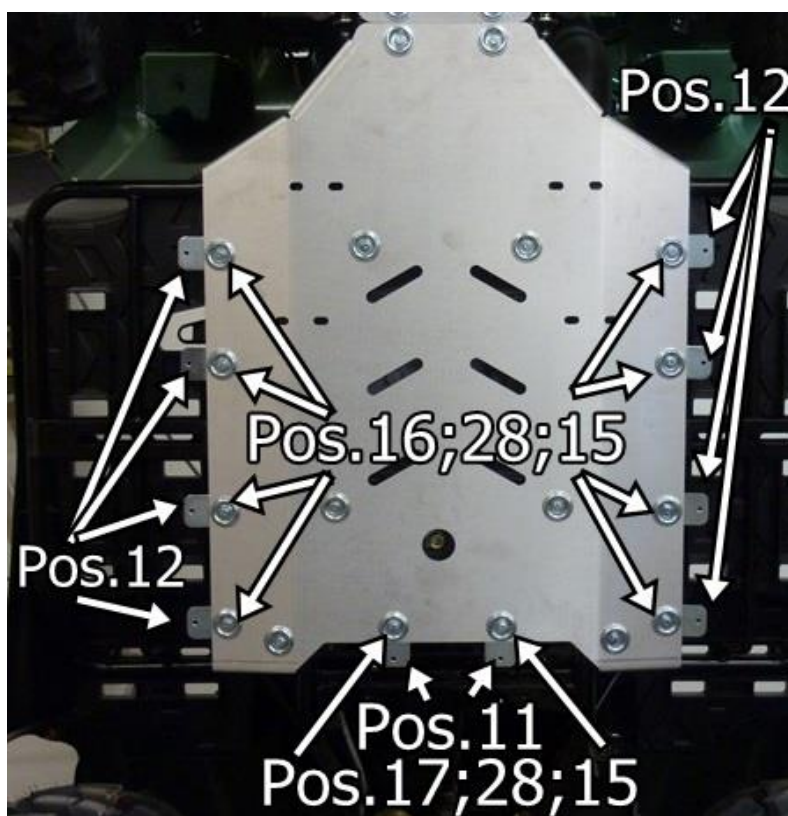

Samm 7

Paigalda põhjakaitsme tagumine osa 02.15403.



Samm 8

Paigalda küljekaitsmed 02.15404 ja 02.15405.

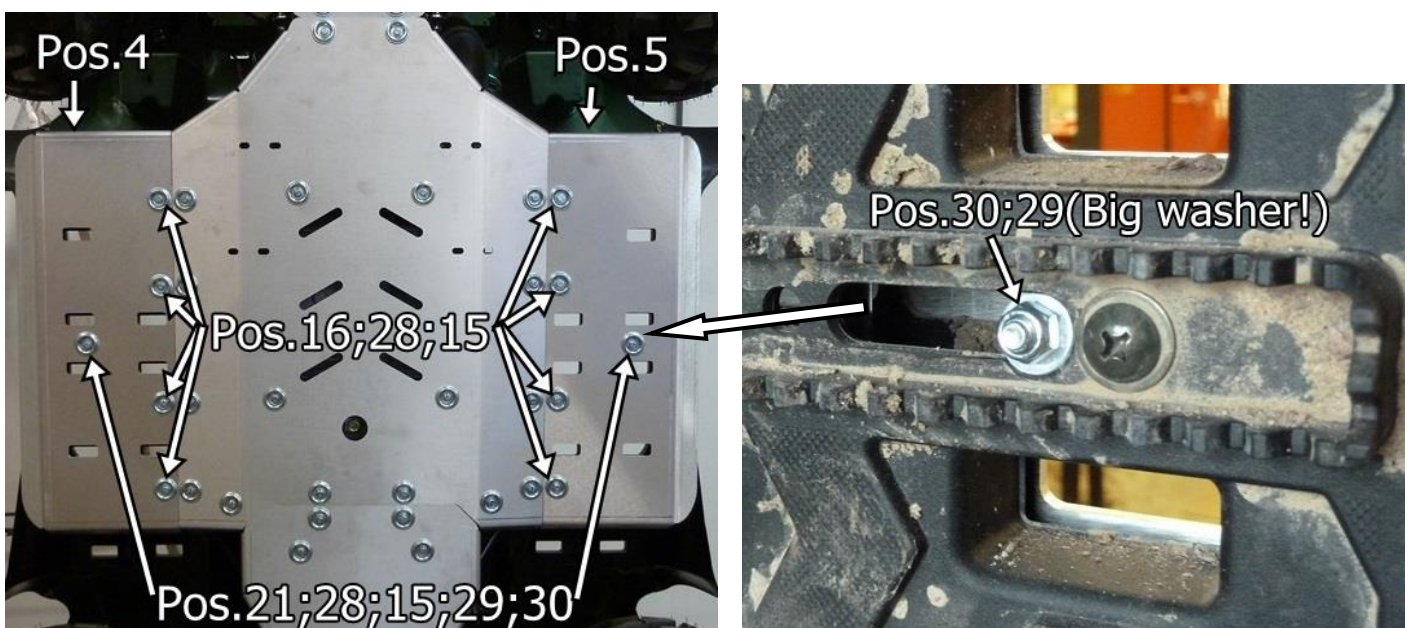

IRON BALTIC

IRON BALTIC OÜ
Joa tee 17
Vääna 76903
Estonia / Europe

+372 6 533 711
sales@ironbaltic.com

www.ironbaltic.com
www.facebook.com/ironbaltic
www.youtube.com/user/ironbalticLtd

