

Cirrus 6.1

User Guide V2.0



VOID

Contents

1	Safety and regulations	4
1.1	Important safety instructions	4
1.2	Limitations	4
1.3	EC declaration of conformity	4
1.4	WEEE directive	4
2	Limited warranty	5
3	Unpacking and Checking	6
4	About	7
4.1	Welcome	7
4.2	Cirrus series overview	7
5	Specifications and dimension	8
5.1	Cirrus 6.1	8
5.1.1	Key features	8
5.1.2	Cirrus 6.1 specifications	8
5.1.3	Cirrus 6.1 dimensions	9
6	Voltage and power settings	10
7	Mounting	11
7.1	Installation safety	11
7.2	Mounting instruction	12
8	Service	15

©2024 Void Acoustics Research Ltd.

Version 2.0

This user guide is subject to change without notice.
For the latest online version, visit: www.voidacoustics.com

Void Acoustics and the Void logo are registered trademarks of Void Acoustics Research Ltd. in the United Kingdom, USA and other countries; all other Void trademarks are the property of Void Acoustics Research Ltd.

1 Safety and regulations

1.1 Important safety instructions



The lightning flash with an arrowhead symbol within an equilateral triangle is intended to alert the user to the presence of uninsulated "dangerous voltage" within the product's enclosure that may be of sufficient magnitude to constitute a risk of electric shock to persons.



The exclamation point within an equilateral triangle is intended to alert the user of the presence of important operating and maintenance (servicing) instructions in the literature accompanying the appliance.

Safety instructions - read this first

1. Read these instructions.
2. Keep these instructions.
3. Heed all warnings.
4. Follow all instructions.
5. Do not use this apparatus near water.
6. Clean only with a dry cloth.
7. Do not block any ventilation openings. Install in accordance with the manufacturer's instructions.
8. Do not install near any heat source such as radiators, heat registers, stoves, or other such apparatus that produce heat.
9. Do not defeat the safety purpose of the grounding-type plug. A grounding type plug has two blades and a third grounding prong. The third prong is provided for your safety. If the provided plug does not fit into your outlet, consult an electrician for replacement of the obsolete outlet.
10. Protect power cords from being walked on or pinched particularly at plugs, convenience receptacles, and the point where they exit the apparatus.
11. Only use attachments and accessories specified by Void Acoustics.
12. Only use with the cart, stand, tripod, bracket, or table specified by the manufacturer, or sold with the apparatus. When a cart is used, use caution when moving the cart/apparatus combination to avoid injury from tip-over.
13. Unplug the apparatus during lightning storms or when unused for long periods of time.
14. Refer all servicing to qualified service personnel. Servicing is required when the apparatus has been damaged in any way, such as when the power-supply cord or plug is damaged, liquid has been spilled or objects have fallen into the apparatus, the apparatus has been exposed to rain or moisture, does not operate normally, or has been dropped.
15. Since the mains power supply cord attachment plug is used to disconnect the device, the plug should always be easily accessible.
16. Void loudspeakers can produce sound levels capable of causing permanent hearing damage from prolonged exposure. The higher the sound level, the less exposure needed to cause such damage. Avoid prolonged exposure to the high sound levels from the loudspeaker.

1.2 Limitations

This guide is provided to help familiarise the user with the loudspeaker system and its accessories. It is not intended to provide comprehensive electrical, fire, mechanical and noise training and is not a substitute for industry-approved training. Nor does this guide absolve the user of their obligation to comply with all relevant safety legislation and codes of practice.

While every care has been taken in creating this guide, safety is user-dependent and Void Acoustics Research Ltd cannot guarantee complete safety whenever the system is rigged and operated.

1.3 EC declaration of conformity

Manufacturer:

Void Acoustics Research Ltd,
Unit 15 Dawkins Road Ind Est,
Poole, Dorset,
BH15 4JY,
United Kingdom.



We declare that under our sole responsibility the following product models: Cirrus 6.1

are intended to be used as loudspeakers and are in conformity with the following EC Directives, including all amendments, and with national legislation implementing these directives:

- BS EN 60065:2002
- BS EN 55103-1/-2

March 2016

Alex Skan
Technical Director

1.4 WEEE directive

If the time arises to throw away your product, please recycle all the components possible.



This symbol indicates that when the end-user wishes to discard this product, it must be sent to separate collection facilities for recovery and recycling. By separating this product from other household-type waste, the volume of waste sent to incinerators or land-fills will be reduced and natural resources will thus be conserved.

The Waste Electrical and Electronic Equipment Directive (WEEE Directive) aims to minimise the impact of electrical and electronic goods on the environment. Void Acoustics Research Ltd complies with the Directive 2002/96/EC and 2003/108/EC of the European Parliament on waste electrical and electronic equipment (WEEE) in order to reduce the amount of WEEE that is being disposed of in land-fill sites. All of our products are marked with the WEEE symbol; this indicates that this product must NOT be disposed of with other waste. Instead it is the user's responsibility to dispose of their waste electrical and electronic equipment by handing it over to an approved reprocessor, or by returning it to Void Acoustics Research Ltd for reprocessing. For more information about where you can send your waste equipment for recycling, please contact Void Acoustics Research Ltd or one of your local distributors.

2 Limited warranty

Limited warranty

The warranty

For a period of three (3) years from the date of delivery to the original purchaser (as shown on the original invoice or sales receipt; a copy of this may be required as proof of warranty dates), Void Acoustics Research Ltd (hereinafter "Void") warrants to the Original Owner (person or company who originally purchased the product brand new from either Void or a Void Authorised Dealer/Distributor) of each new Cirrus Series product (provided it was purchased at an Authorised Void Dealer) that it is free of defects in materials and workmanship and that each product will meet or exceed all factory published specifications for each respective model. Void agrees to repair or replace (at its discretion) all defective parts at no charge for labour or materials; subject to the following provisions:

Warranty violations

Void shall take no responsibility for repair or replacement as specified under this warranty, if the damaged product has been subject to misuse, accident, neglect or failure to comply with normal maintenance procedures; or if the serial number has been defaced, altered or removed. Nor will Void accept responsibility for, or resulting from, improper alterations or unauthorised parts or repairs. This warranty does not cover any damage to speakers or any other consequential damage resulting from breach of any written or implied warranty.

Void warranty provisions

Void will remedy any defect, regardless of the reason for failure (except as excluded) by repair, or replacement. Void will remedy the defect and ship the product within a reasonable time after receipt of the defective product at a Void Authorised Service Centre.

To obtain warranty service

If a Void product requires service, the Owner must contact Void or an Authorised Void Service Centre to receive an R.A.N. (Return Authorisation Number) and instructions on how to return the product to the Void Authorised Service Centre, or to Void.

Void (or its Authorised Service Centre) will initiate corrective repairs upon receipt of the returned product. Please save the original carton and all the packing materials in case shipping is required. All products being returned to the factory or service centre for repairs must be shipped prepaid.

If the repairs made by Void or the Void Authorised Service Centre are not satisfactory, the Owner is instructed to give written notice to Void. If the defect or malfunction remains after a reasonable number of attempts by Void to remedy the defect or malfunction, the Original Owner shall then have the option to elect either a refund or replacement of said Void product free of charge. The refund shall be an amount equal to but not greater than the actual purchase price, not including any taxes, interest, insurance, closing costs and other finance charges (minus reasonable depreciation on the product). If a refund is necessary, the Original Owner must make the defective or malfunctioning product available to Void free and clear of all liens or other restrictions.

Equipment modifications

Technical and design specifications are subject to change without notice.

Void reserves the right to modify or change equipment (in whole or part) at any time prior to delivery thereof, in order to include therein electrical or mechanical improvements deemed appropriate by Void, but without incurring any liability to modify or change any equipment previously delivered, or to supply new equipment in accordance with any earlier specifications.

Disclaimer of consequential and incidental damages

You, the Original Owner, are not entitled to recover from Void any incidental damages resulting from any defect in the Void product.

This includes any damage to another product or products resulting from such a defect.

Warranty alterations

No person has the authority to enlarge, amend, or modify this Warranty. This Warranty is not extended by the length of time which the Original Owner is deprived of the use of product. Repairs and replacement parts provided pursuant to the Warranty shall carry only the non-expired portion of the Warranty.

This Statement of Warranty supersedes all others contained in this user guide.

3 Unpacking and checking

All Void Acoustics products are carefully manufactured and thoroughly tested before being despatched. Your dealer will ensure that your Void products are in pristine condition before being forwarded to you but mistakes and accidents can happen.

Before signing for your delivery:

- Inspect your shipment for any signs of contamination, abuse or transit damage as soon as you receive it
- Check your Void Acoustics delivery fully against your order
- If your shipment is incomplete or any of its contents are found to be damaged; inform the shipping company and inform your dealer.

See section 2 for warranty conditions and see section 8 if your product needs service.

4 About

4.1 Welcome

Many thanks for purchasing this Void Acoustics Cirrus 6.1. We truly appreciate your support. At Void, we design, manufacture and distribute advanced professional audio systems for the installed and live sound market sectors. Like all Void products, our highly skilled and experienced engineers have successfully combined pioneering technologies with ground-breaking design aesthetics, to bring you superior sound quality and visual innovation. In buying this product, you are now part of the Void family and we hope using it brings you years of satisfaction. This guide will help you both use this product safely and ensure it performs to its full capability.

4.2 Cirrus series overview

Cirrus ceiling loudspeakers bring Void's quality and attention to detail to the commercial install sector. Designed for quick and easy installation, Cirrus delivers fidelity levels worthy of the Void badge. With an understated, discreet appearance, the 70V/100V line integration, multiple wattage taps and low impedance setting allow for seamless audio matching.

5 Specifications and dimensions

5.1 Cirrus 6.1

5.1.1 Key features

- Internal 100V/70V line transformer
- Selectable voltage taps and low impedance setting
- Wide 110° dispersion pattern
- Paintable white ABS enclosure
- 6.5" low frequency driver
- 0.75" coaxially mounted high frequency driver
- Quick and easy ceiling mount fixings

5.1.2 Cirrus 6.1 specifications

Frequency Response	96Hz ~ 18KHz (-3dB) / 62Hz ~ 20KHz (-10dB)
Efficiency ¹	90 dB 1W/1m
Crossover Points	3.3 kHz passive
Nominal Impedance	8 Ω
Power Handling ²	100 W AES
Voltage Taps	100 V - 30 W, 15 W, 7.5 W 70 V - 30 W, 15 W, 7.5 W and 3.8 W
Maximum Output ³	110 dB cont, 116 dB peak
Driver Configuration	1 x 6.5" LF, 1 x 0.75" HF
Dispersion	110°
Connectors	Removable locking connector with screw-down terminals. Two input terminals and two loop-thru output terminals. Max. wire 12 AWG (2.5 mm ²)
Weight	3.5 kg (7.7 lbs)
Enclosure	ABS baffle
Mounting	Backing plate and tiles rails (included)
Colour	White
Construction Note	Mounting hole 224 mm (8.8") diameter

¹ Measured in half space ² AES2 - 1984 compliant ³ Calculated

5 Specifications and dimensions

5.1.3 Cirrus 6.1 dimensions

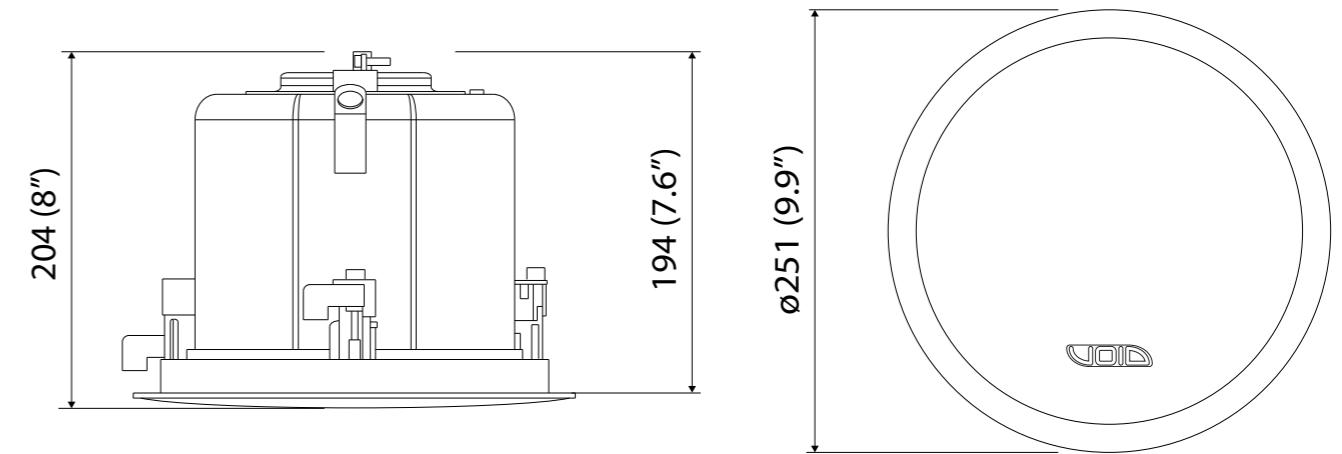

Figure 5.2: Cirrus 6.1 dimensions

6 Voltage and power setting

The Cirrus 6.1 operate at 8 Ohms directly or at 100 V or 70 V operation through line transformers from the switch on the baffle.

Model	8 Ohm	100 V	70 V
Cirrus 6.1	100 W	30 W, 15 W, 7.5 W	30 W, 15 W, 7.5 W and 3.8 W



Figure 6.1: Baffle switch location

7 Mounting

Tools required

Cross head screw driver

7.1 Installation safety



To avoid mechanical hazards, please note the following:

- Safety regulations vary in different regions. Full compliance with those regulations must be your priority
- Rigging must only be undertaken by fully-qualified and experienced riggers who understand local regulations
- This may include consulting a structural engineer before installation of wall brackets
- Remember that all personnel have a duty of care to themselves, to their assistants, to the venue staff and to the public
- Before lifting any part of the system above head height, check the whole rig for loose tools or other items that may fall and cause injury
- Do not use a telephone (even if hands-free) while rigging. Always concentrate fully on the rigging operation
- Do not rig equipment that is worn, damaged, corroded, mishandled or over-stressed in any way
- Use only Void-approved mounting equipment and accessories.
- Secondary safeties should be provided in all instances where cabinets are flying or fixing overhead and should conform to local regulations

7 Mounting

7.2 Mounting instructions

Step 1:

Cut the hole in the ceiling using the following dimensions or the cut out provided with the Cirrus series loudspeaker:

Cirrus 6.1	224 mm (8.8")
------------	---------------

Step 2:

Lay the tile rail either side of the hole and put the C-bracket over the vertical edges of the rails as shown in the image below.

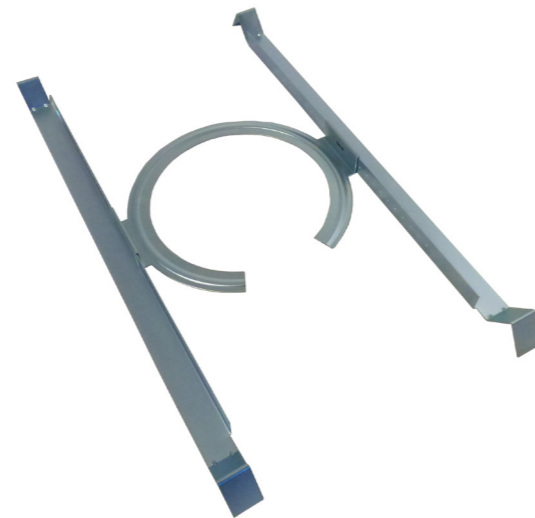

Figure 7.1: C-bracket and rails

Step 3:

Attach the C-bracket to the rail with the screws provided

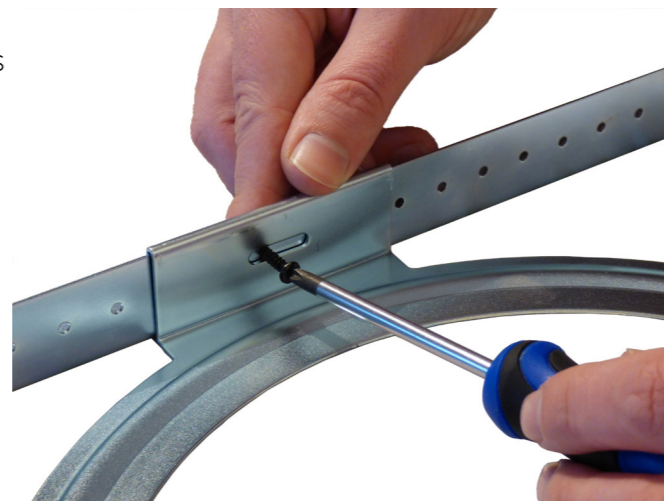

Figure 7.2: Attaching C-bracket to rail

7 Mounting

Step 4:

Insert the Cirrus series loudspeaker through the ceiling hole and the C-bracket ensuring that the swivel tabs do not align with the gap in the bracket.

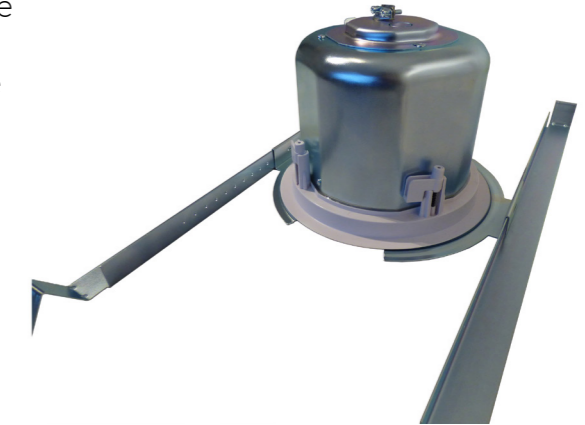

Figure 7.3: Loudspeaker positioning

Step 5:

Tighten all four screws in the baffle plate to engage the swivel tabs and lock onto the C-bracket.



Figure 7.4: Engaging the swivel tabs

Step 6:

Connect the amplifier cable to the loudspeaker. The Cirrus series loudspeakers have a 4 pin terminal that allows for + (2) and - (3) for input and + (1) and - (4) link out.

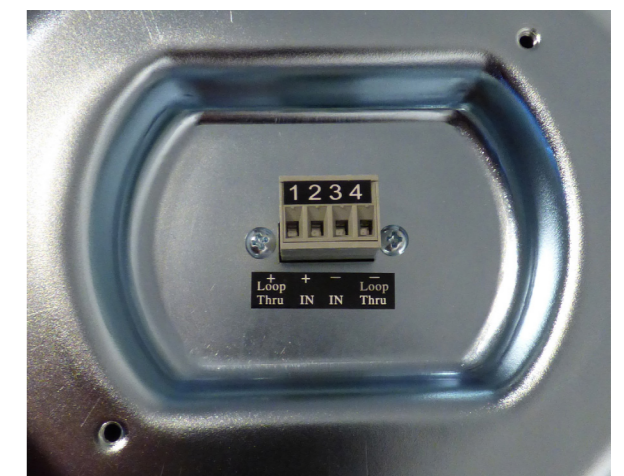

Figure 7.5: Terminal layout

7 Mounting

Step 7:
Reattach the steel fire proof cover to the loudspeaker enclosure and attach the clamp to the cable to ensure fire protection.

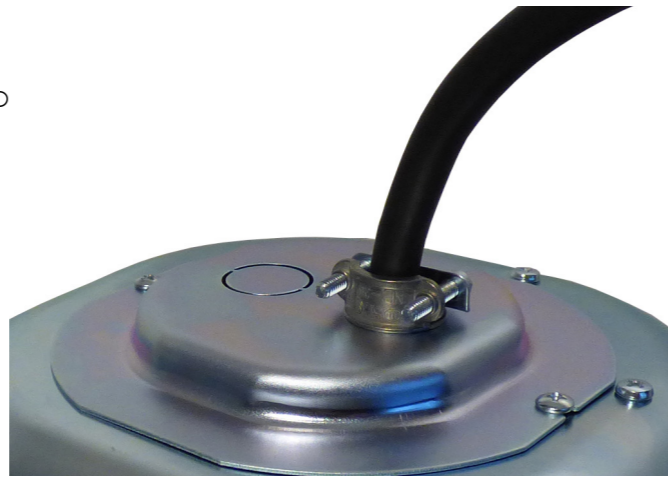

Figure 7.6: Fire proof cover placement

Step 8:
Attach a steel safety wire, rated to local regulations, to the safety tag.

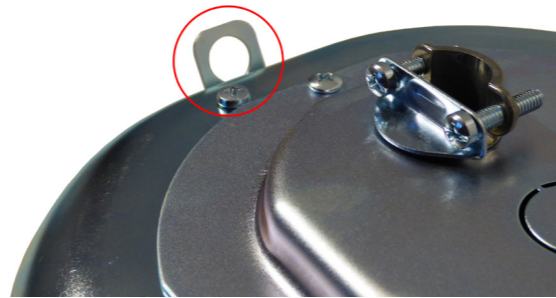

Figure 7.7: Safety tag

Step 9:
Push the grille into position.



Figure 7.8: Grille positioning

8 Service

Void Cirrus loudspeakers should only be serviced by a fully-trained technician.



No user serviceable parts inside. Refer servicing to your dealer.

8.1 Return authorisation

Before returning your faulty product for repair, please remember to get an R.A.N. (Return Authorisation Number) from the Void dealer who supplied the system to you. Your dealer will handle the necessary paperwork and repair. Failure to go through this return authorisation procedure could delay the repair of your product.

Note that your dealer will need to see a copy of your sales receipt as proof of purchase so please have this to hand when applying for return authorisation.

8.2 Shipping and packing considerations

- When sending a Void Cirrus loudspeaker to an authorised service centre, please write a detailed description of the fault and list any other equipment used in conjunction with the faulty product.
- Accessories will not be required. Do not send the instruction manual, cables or any other hardware unless your dealer asks you to.
- Pack your unit in the original factory packaging if possible. Include a note of the fault description with the product. Do not send it separately.
- Ensure safe transportation of your unit to the authorised service centre.

Page intentionally left blank

Page intentionally left blank

North America

Void Acoustics North America

+1 (630) 686-6616

hello@voidacoustics.com

Head Office

Void Acoustics Research Ltd
Unit 15 Dawkins Road Industrial Estate
Poole
Dorset
BH15 4JY
England

+44 (0) 1202 666 006

hello@voidacoustics.com

Registered in England & Wales No. 07533536

www.voidacoustics.com

